

SWING GATE

SAFETY GATES

Revision: 30 May 2024 5:03 PM
Boplan reference: SG11...

PRODUCT SPECIFICATIONS

APPLICATION

Environment	Self-closing gate for indoor and outdoor walkway control in industrial settings.
Features	<ul style="list-style-type: none"> Robust, impact-resistant components Smooth rounded design to prevent injuries such as bruises or cuts Fully made of polymer Hinge, springs and screws all zinc coated or stainless steel (SS 304) Integrated sign board Turns open in both directions When opened over more than 90°, the gate remains open. Range of standard lengths available UV resistant Durable, made for intensive use (Positively tested up to 100.000 cycles)

MATERIAL

Main gate components	Extrilene® - UV resistant - Fire class E ^s - Non conductive - Impervious to most chemicals ^{**}
Fixations and springs	Zinc coated and stainless steel (SS 304) version available

STANDARD COLOURS

Gate rails	Black RAL 9005 / Yellow RAL 1003
Sign board	Black RAL 9005

FIXATIONS (included)

To fix hinge (on a FLEX IMPACT® post)	Bolts: M6x40mm (8x)	
--	---------------------	---

^{*}Classification according to EN 13501-1:2007 +A1:2009 - Fire classification of construction products and building elements.
^{**}Ask your local sales office for resistance to specific chemicals.

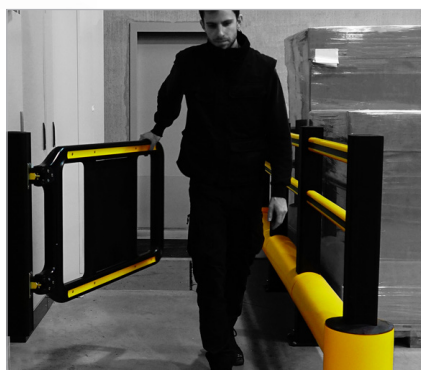
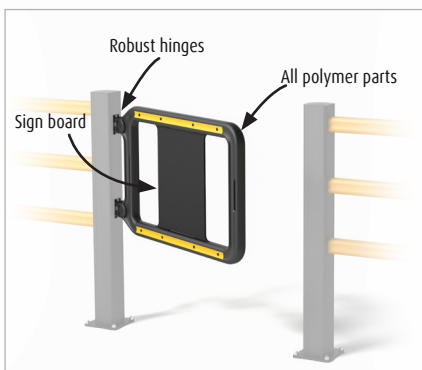
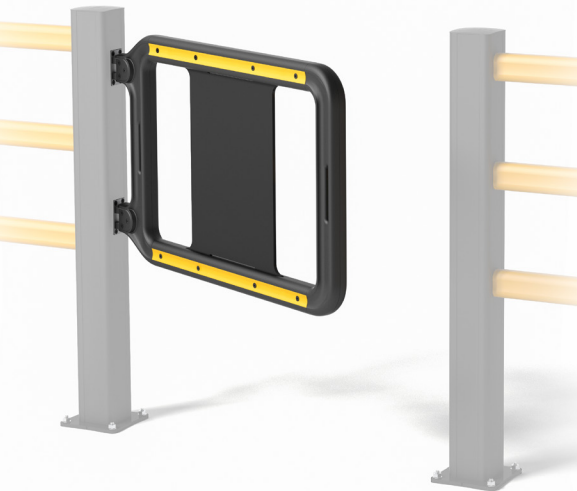

FEATURES AND FUNCTIONALITY - SG SWING GATE

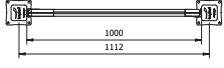
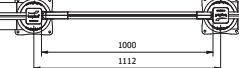
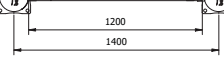
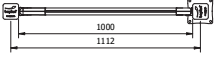



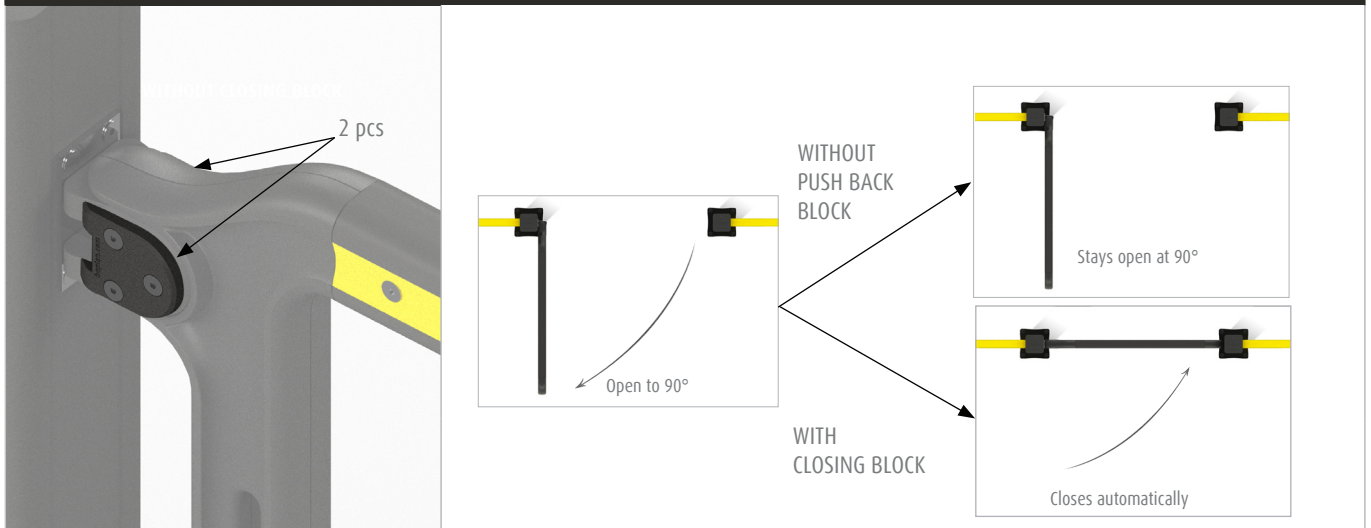

ATTACH TO	
HP plus - posts	
TB400 Plus TB260 Plus	
Bollard impact	
HP plus - wall mount	

REQUIREMENTS	
Compatible	HP Plus handrails systems TB400 Plus TB260 Plus BO Impact
Environment	Zinc coated (ZC): Suitable for outdoor use in most environments. Stainless steel (SS): Suitable for outdoor use or frequent exposure to water and humidity, as typically in food processing industry.
Operational temperature	-10°C up to + 40°C
Food proof	No
Use	To be opened manually. Not intended for vehicle impact. Do not force the gate open past 90°
ACCESSORIES (included)	
Push back block (2pcs)	 [included] The Closing blocks prevent the swing gate from remaining open. (details - see below)
Gate stop rubber	 [included] The rubber stop can be mounted on a post or a wall. Fixation included.

PUSH BACK BLOCK





REFERENCE LIST - SG SWING GATE

	Zinc coated	Stainless steel	
700mm	SG1100-0700-0001BYZC	SG1100-0700-0001BYS	 Post NOT included
800mm	SG1100-0800-0001BYZC	SG1100-0800-0001BYS	 Post NOT included
900mm	SG1100-0900-0001BYZC	SG1100-0900-0001BYS	 Post NOT included
1000mm	SG1100-1000-0001BYZC	SG1100-1000-0001BYS	 Post NOT included
1250mm	SG1100-1250-0001BYZC	SG1100-1250-0001BYS	 Post NOT included
1500 mm	SG1100-1500-0001BYZC	SG1100-1500-0001BYS	 Post NOT included
2000 mm + guiding roller	SG1100-2000-0001BYZC	SG1100-2000-0001BYS	 Post NOT included

	Zinc coated	Stainless steel	
701 - 999mm Black/Yellow	SG1101-0999-0001BYZC	SG1101-0999-0001BYS	 Post NOT included
1001 - 1499mm Black/Yellow	SG1101-1499-0001BYZC	SG1101-1499-0001BYS	 Post NOT included
1501 - 1999 mm Black/Yellow + guiding roller	SG1101-1999-0001BYZC	SG1101-1999-0001BYS	 Post NOT included

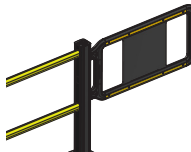
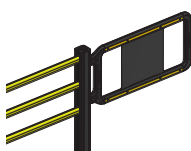
REFERENCE LIST - SG SWING GATE
SWING GATE - HP POST

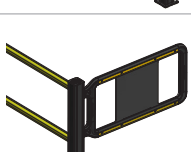
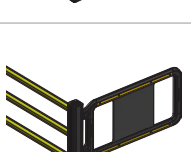
SG1199-0001-BPBL SG1199-0001-BPBLZ SG1199-0001-BPBL5	SG post HP - Blank - BL SG post HP - Blank - BL - ZC SG post HP - Blank - BL - SS	
SG1199-0001-C2BL SG1199-0001-C2BLZ SG1199-0001-C2BL5	SG post HP - Cont.2R - BL SG post HP - Cont.2R - BL - ZC SG post HP - Cont.2R - BL - SS	
SG1199-0001-C3BL SG1199-0001-C3BLZ SG1199-0001-C3BL5	SG post HP - Cont.3R - BL SG post HP - Cont.3R - BL - ZC SG post HP - Cont.3R - BL - SS	
SG1199-0090-SGD2BL SG1199-0090-SGD2BLZ SG1199-0090-SGD2BL5	SG post HP - 90° Down (2R) - BL SG post HP - 90° Down (2R) - BL - ZC SG post HP - 90° Down (2R) - BL - SS	
SG1199-0090-SGD3BL SG1199-0090-SGD3BLZ SG1199-0090-SGD3BL5	SG post HP - 90° Down (3R) - BL SG post HP - 90° Down (3R) - BL - ZC SG post HP - 90° Down (3R) - BL - SS	
SG1199-0090-SGU2BL SG1199-0090-SGU2BLZ SG1199-0090-SGU2BL5	SG post HP - 90° Up (2R) - BL SG post HP - 90° Up (2R) - BL - ZC SG post HP - 90° Up (2R) - BL - SS	
SG1199-0090-SGU3BL SG1199-0090-SGU3BLZ SG1199-0090-SGU3BL5	SG post HP - 90° Up (3R) - BL SG post HP - 90° Up (3R) - BL - ZC SG post HP - 90° Up (3R) - BL - SS	

SWING GATE - HP POST - WALL MOUNT

SG1699-0750-WMHPBL	SG post HP - Wall mounted - 750mm - BL	
--------------------	--	---

SWING GATE - TB260 PLUS POST

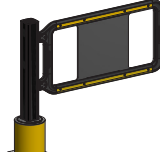
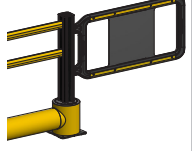
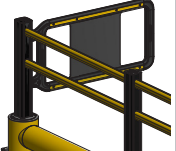
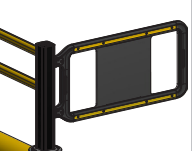
SG1299-0002-SGBPYE SG1299-0002-SGBPYEZ SG1299-0002-SGBPYES	SG post TB260 Plus - Blank - YE SG post TB260 Plus - Blank - YE - ZC SG post TB260 Plus - Blank - YE - SS	
SG1299-0002-SGC2YE SG1299-0002-SGC2YEZ SG1299-0002-SGC2YES	SG post TB260 Plus - Continu TB - YE SG post TB260 Plus - Continu TB - YE - ZC SG post TB260 Plus - Continu TB - YE - SS	
SG1299-0092-SGD2YE SG1299-0092-SGD2YEZ SG1299-0092-SGD2YES	SG post TB260 Plus - 90° Down TB - YE SG post TB260 Plus - 90° Down TB - YE - ZC SG post TB260 Plus - 90° Down TB - YE - SS	
SG1299-0092-SGU2YE SG1299-0092-SGU2YEZ SG1299-0092-SGU2YES	SG post TB260 Plus - 90° Up TB - YE SG post TB260 Plus - 90° Up TB - YE - ZC SG post TB260 Plus - 90° Up TB - YE - SS	

REFERENCE LIST - SG SWING GATE

SWING GATE - TB400 PLUS POST		SWING GATE - BOLLARD IMPACT			
SG1299-0001-SGBPYE SG1299-0001-SGBPYEZ SG1299-0001-SGBPYES	SG post TB400 Plus - Blank - YE SG post TB400 Plus - Blank - YE - ZC SG post TB400 Plus - Blank - YE - SS		SGBO200-0001-BPYEZ SGBO200-0001-BPYES	SG Bollard Impact - Blank - YE - ZC SG Bollard Impact - Blank - YE - SS	
SG1299-0001-SGC2YE SG1299-0001-SGC2YEZ SG1299-0001-SGC2YES	SG post TB400 Plus - Continu TB - YE SG post TB400 Plus - Continu TB - YE - ZC SG post TB400 Plus - Continu TB - YE - SS		SGBO200-0001-DPC2YEZ SGBO200-0001-DPC2YES	SG Bollard Impact - Continu 1R(DP) - YE - ZC SG Bollard Impact - Continu 1R(DP) - YE - SS	
SG1299-0090-SGD2YE SG1299-0090-SGD2YEZ SG1299-0090-SGD2YES	SG post TB400 Plus - 90° Down TB - YE SG post TB400 Plus - 90° Down TB - YE - ZC SG post TB400 Plus - 90° Down TB - YE - SS		SGBO200-0001-TPC2YEZ SGBO200-0001-TPC2YES	SG Bollard Impact - Continu 2R(TB) - YE - ZC SG Bollard Impact - Continu 2R(TB) - YE - SS	
SG1299-0090-SGU2YE SG1299-0090-SGU2YEZ SG1299-0090-SGU2YES	SG post TB400 Plus - 90° Up TB - YE SG post TB400 Plus - 90° Up TB - YE - ZC SG post TB400 Plus - 90° Up TB - YE - SS		SGBO200-0001-HPC2YEZ SGBO200-0001-HPC2YES	SG Bollard Impact - Continu 2R(HP) - YE - ZC SG Bollard Impact - Continu 2R(HP) - YE - SS	
			SGBO200-0001-HPC3YEZ SGBO200-0001-HPC3YES	SG Bollard Impact - Continu 3R(HP) - YE - ZC SG Bollard Impact - Continu 3R(HP) - YE - SS	
			SGBO200-0090-TPD2YEZ SGBO200-0090-TPD2YES	SG Bollard Impact - 90° Down 2R(TB) - YE - ZC SG Bollard Impact - 90° Down 2R(TB) - YE - SS	
			SGBO200-0090-HPD2YEZ SGBO200-0090-HPD2YES	SG Bollard Impact - 90° Down 2R(HP) - YE - ZC SG Bollard Impact - 90° Down 2R(HP) - YE - SS	

REFERENCE LIST - SG SWING GATE

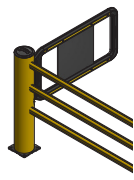
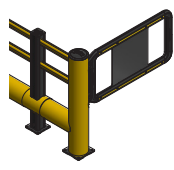
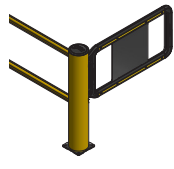
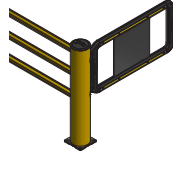
REFERENCES - SWING GATE - BOLLARD IMPACT	
SGB0200-0090-HPD3YEZ SGB0200-0090-HPD3YES	SG Bollard Impact - 90° Down 3R(HP) - YE - ZC SG Bollard Impact - 90° Down 3R(HP) - YE - SS 
SGB0200-0090-TPU2YEZ SGB0200-0090-TPU2YES	SG Bollard Impact - 90° Up 2R(TB) - YE - ZC SG Bollard Impact - 90° Up 2R(TB) - YE - SS 
SGB0200-0090-HPU2YEZ SGB0200-0090-HPU2YES	SG Bollard Impact - 90° Up 2R(HP) - YE - ZC SG Bollard Impact - 90° Up 2R(HP) - YE - SS 
SGB0200-0090-HPU3YEZ SGB0200-0090-HPU3YES	SG Bollard Impact - 90° Up 3R(HP) - YE - ZC SG Bollard Impact - 90° Up 3R(HP) - YE - SS 

REFERENCES - SWING GATE - SPARE PARTS	
SG0109-0002-PBBL	SG Push back block (2 pieces) - BL 
SG9901-0001-PWMBL	Gate stop - BL Post/Wall mounted sustainable elastomer (SS fixations included) 
SG1109-0001-GRBLZC SG1109-0001-GRS	Guiding roller - BL - ZC Guiding roller - SS 
SG1109-0001-ERBLZC SG1109-0001-ERBLS	End Connection (Fixations ZC) End Connection (Fixations SS) 
SG1109-0001-HRBLZC SG1109-0001-HRBLS	Hinge Connection (Fixations ZC) Hinge Connection (Fixations SS) 
SG1109-0001-HCSZ SG1109-0001-HCSS	Hinge (1pcs) for SG ≤1000 mm - ZC Hinge (1pcs) for SG ≤1000 mm - SS 
SG1109-0001-HSSZ SG1109-0001-HSSS	Hinge (1pcs) for SG >1000 ≤1500 mm - ZC Hinge (1pcs) for SG >1000 ≤1500 mm - SS 
SG1109-0001-HDSZ SG1109-0001-HDSS	Hinge (1pcs) for SG >1500mm - ZC Hinge (1pcs) for SG >1500mm - SS 

TECHNICAL DRAWINGS - SG SWING GATE

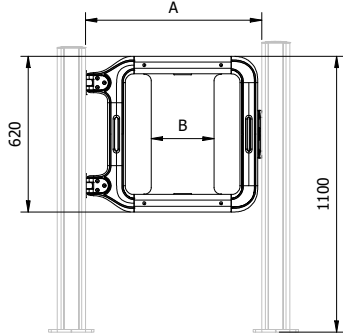

Gate opening (A)	board size (B)
700 mm	250 mm
800 mm	
900 mm	
701-999 mm	

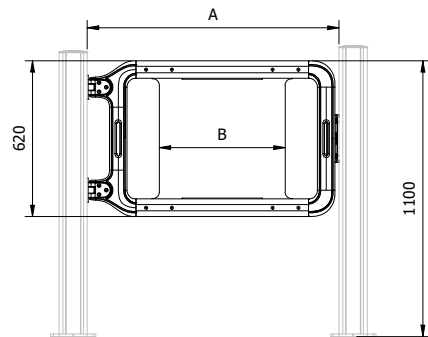

Gate opening (A)	board size (B)
1000 mm	500 mm
1250 mm	
1500 mm	
1001-1499 mm	

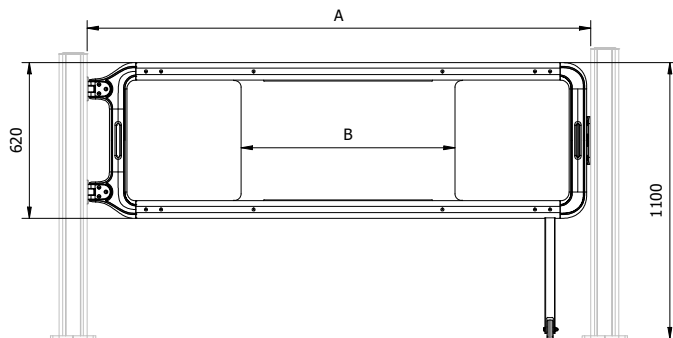

Gate opening (A)	board size (B)
2000 mm	850 mm
1501-1999	