

HP PLUS 3R HANDRAILS

Revision: 31 March 2025 9:08 AM
Boplan reference: HP1120-...







PRODUCT SPECIFICATIONS

| APPLICATION | | | |
|---------------------------|--|--|-------------------------|
| Protection | Robust handrail system for the physical demarcation of pedestrian zones. | | |
| Impact performance at 90° | POST: | 3300 Joule (Eq. to 2,5 ton - 5,8 km/h) | |
| | RAIL: | 5500 Joule (Eq. to 2,5 ton - 7,5 km/h) | |
| MATERIAL | | | |
| Posts and rails | Extrilene® - UV resistant - Fire class E* - Non conductive - Impervious to most chemicals** | | |
| Caps | Sustainable elastomer | | |
| STANDARD COLOURS | | | |
| End post / Mid post | Standard: Yellow RAL 1003 Alternative: Black RAL 9005 | | |
| Handrails | Standard: Yellow RAL 1003 Alternative: Black/Photolum; Black/Red; Black/Yellow; Yellow/black; Yellow/Photolum | | |
| BASEPLATES | | | |
| | Steel | Zinc Coated Steel | Stainless steel |
| Material | Steel 37 | Steel 37 | Stainless steel 304 |
| Coating | Lacquered | Electroplated + Laquered | No lacquer / No coating |
| Colour | High gloss black | Mat black | Natural colour |

*Classification according to EN 13501-1:2007 +A1:2009 - Fire classification of construction products and building elements.

**Ask your local sales office for resistance to specific chemicals.

| FIXATIONS | | | |
|--------------|-----------------------|---|------------------------------|
| | | ZC (Zinc coated) | SS (Stainless steel) |
| STANDARD | Wedge anchor |  M12 x 120mm | M12 x 120mm |
| | Anchor rod (Chemical) |  M12 x 120mm + Chemical resin | M12 x 120mm + Chemical resin |
| ALTERNATIVES | Concrete screw |  Ø12mm x 100mm | Not available |
| | Asphalt anchor |  Bolt M10 x 40mm + Screw Ø16mm | Not available |
| | Spit anchor |  Bolt M12 x 100mm + Plug Ø20mm | Not available |

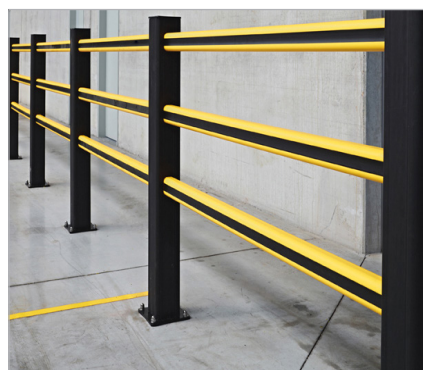

FEATURES AND FUNCTIONALITY - HP PLUS 3R

| SIZE | |
|--------------------------|--|
| Height end / mid posts | 1150 mm |
| Profile section handrail | 50 mm x 70 mm (6 mm wall thickness) |
| Profile section posts | 112 mm x 112 mm (10 mm wall thickness) |
| Standard rail length | Standard length: 1500 mm (center - center dimension) |
| Baseplate | 180 mm x 180 mm (10 mm thick) |

IMPACT LABEL FOR SAFETY BARRIERS

| BOPLAN HP PLUS 3R | | |
|--------------------------|---------------|---------------|
| IMPACT RATING | 45° | 90° |
| E80 > 80 kJ | | |
| E60 > 60 kJ | | |
| E50 > 50 kJ | | |
| E40 > 40 kJ | | |
| E35 > 35 kJ | | |
| E30 > 30 kJ | | |
| E25 > 25 kJ | | |
| E20 > 20 kJ | | |
| E15 > 15 kJ | | |
| E10 > 10 kJ | 7,8 kJ | 5,5 kJ |
| E5 > 5,0 kJ | | |
| E2 > 2,5 kJ | | |

TEST CONDITIONS

TEMPERATURE: 20°C / 68°F

IMPACT HEIGHT: 500 mm / 20 inch

IMPACT ANGLE: 90°

TEST FLOOR: CONCRETE SLAB C25/30 - 160 mm / 6 inch

MANUFACTURER ANCHOR PULL OUT: 7,9 kN

TEST VEHICLE

WEIGHT: 2300 KG / 5070.63 lbs

TYPE: COMMERCIAL FORK LIFT

SIZE (L x W x H): 1890x1020x1970 mm / 74x40x78 inch

CONTACT AREA: STEEL BUMPER WIDTH: 600 mm / 24 inch

BOPLAN TEST CENTRE

Muizelstraat 12
8560 Moorsele
Belgium

Approved by:

TÜV NORD Systems

IL-HP112-20230710

| REQUIREMENTS | |
|---|---|
| Concrete quality | minimum C25/30 |
| Concrete floor plate thickness (mm) | minimum 150 mm |
| Concrete slab dimension around posts (mm) | 400 (h) x 400 (w) x 300 (d) |
| Operational temperature | -10°C up to +40°C |
| Water and humidity | Steel (standard): dry indoor use only. Zinc coated: outdoor use in most environments. Stainless steel: outdoor use or frequent exposure to water and humidity. |

COMPLIANCE

The HP PLUS handrail complies with safety standard EN14122-3 chapter 7 and 8 related to the strength of the rails and posts. Tested and approved by **TUV Nord**.

CERTIFICATE

FOR DETERMINING THE PRODUCT TYPE

07/203/VKBÜZ/8121248350/23/KSP1(00)

According to the certification program ST1125-KSP-UN-3202 of TÜV NORD Systems GmbH & Co. KG for Plastics Products, this certificate applies to the product:

Handrail HP Plus 20/20R
Handrail HD Light / Mezza
placed on the market under the name or brand:
Handrail HP Plus 20/20R
Handrail HD Light / Mezza
and produced in the manufacturing plant(s):

Staples BV
Muizelstraat 12
8560 Moorsele (Belgium), Belgium

This certificate attests that at least criteria for the determination of the product characteristics and for the determination of the product type described in the technical specification:

DIN EN ISO 14122-3, especially Chapter 8.2

Please note: responsibility according to the EU Machinery Directive 2006/42/EC is not part of this contract, and is mentioned in the test report: 123040322281 (ref:1248350-781)

It has been noted and that the manufacturer is effectively applying a quality management system with respect to the manufacture of described plastic product.

The manufacturer is responsible for the validity of the products manufactured and marked by him according to the technical specifications.

This certificate was first issued 05.05.2023 and will remain valid until 03.2026 as long as neither the specifications in the referenced technical specifications, the plastic contract nor the recipient's supply and manufacturing conditions in the plant are modified significantly, unless suspended or withdrawn by the certification body.

Nürnberg, 05.05.2023

2023-05-05

VERI-012-2023

TÜV NORD Systems GmbH & Co. KG

Castle Derwentstr. 51

42699 Solingen

Phone: +49 2124 7400-1

www.tuv-nord.com







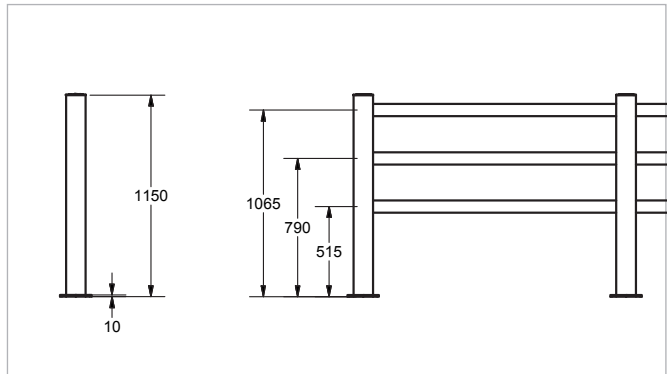
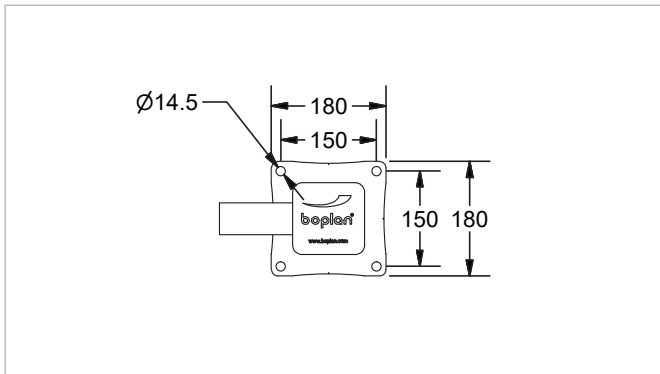

© TÜV NORD Systems GmbH & Co. KG

TÜV NORD Digitally signed by **Biel Andreas**

Certification Body for Plastics Products of TÜV NORD Systems GmbH

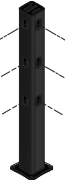

REFERENCE LIST - HP PLUS 3R

| POSTS | | | | POSTS | | | |
|---|---|--|--|---|---|--|--|
| | BLACK | MULTI Colour  | | | BLACK | MULTI Colour  | |
| End post - 3R End post - 3R - ZC End post - 3R - SS End post - 3R - CH End post - 3R - CH - ZC End post - 3R - CH - SS | HP1120-0001-EPBL HP1120-0001-EPBLZ HP1120-0001-EPBLS HP1120-0001-EPBLC HP1120-0001-EPBLZC HP1120-0001-EPBLCS | HP1120-0001-EPMC HP1120-0001-EPMCZ HP1120-0001-EPMCS - - - |  | Blank post - 3R Blank post - 3R - ZC Blank post - 3R - SS Blank post - 3R - CH Blank post - 3R - CH - ZC Blank post - 3R - CH - SS | HP1120-0001-BPBL HP1120-0001-BPBLZ HP1120-0001-BPBLS HP1120-0001-BPBLC HP1120-0001-BPBLZC HP1120-0001-BPBLCS | HP1120-0001-BPMC HP1120-0001-BPMCZ HP1120-0001-BPMCS - - - |  |
| Mid post - 3R Mid post - 3R - ZC Mid post - 3R - SS Mid post - 3R - CH Mid post - 3R - CH - ZC Mid post - 3R - CH - SS | HP1120-0001-MPBL HP1120-0001-MPBLZ HP1120-0001-MPBLS HP1120-0001-MPBLC HP1120-0001-MPBLZC HP1120-0001-MPBLCS | HP1120-0001-MPMC HP1120-0001-MPMCZ HP1120-0001-MPMCS - - - |  | Corner post 90° - 3R Corner post 90° - 3R - ZC Corner post 90° - 3R - SS Corner post 90° - 3R - CH Corner post 90° - 3R - CH - ZC Corner post 90° - 3R - CH - SS | HP1120-0001-C90BL HP1120-0001-C90BLZ HP1120-0001-C90BLS HP1120-0001-C90BLC HP1120-0001-C90BLZC HP1120-0001-C90BLCS | HP1120-0001-C90MC HP1120-0001-C90MCZ HP1120-0001-C90MCS - - - |  |
| T - post - 3R T - post - 3R - ZC T - post - 3R - SS T - post - 3R - CH T - post - 3R - CH - ZC T - post - 3R - CH - SS | HP1120-0001-TPBL HP1120-0001-TPBLZ HP1120-0001-TPBLS HP1120-0001-TPBLC HP1120-0001-TPBLZC HP1120-0001-TPBLCS | HP1120-0001-TPMC HP1120-0001-TPMCZ HP1120-0001-TPMCS - - - |  | Corner post 135° - 3R Corner post 135° - 3R - ZC Corner post 135° - 3R - SS Corner post 135° - 3R - CH Corner post 135° - 3R - CH - ZC Corner post 135° - 3R - CH - SS | HP1120-0001-C45BL HP1120-0001-C45BLZ HP1120-0001-C45BLS HP1120-0001-C45BLC HP1120-0001-C45BLZC HP1120-0001-C45BLCS | HP1120-0001-C45MC HP1120-0001-C45MCZ HP1120-0001-C45MCS - - - |  |

RAIL SETS (3R)

| center - center length | BLACK / PHOTOLUM | BLACK / RED | BLACK / YELLOW | YELLOW / BLACK | YELLOW | YELLOW / PHOTOLUM |
|------------------------|--------------------|--------------------|--------------------|--------------------|--------------------|--------------------|
| 500 mm | HP1120-0500-0001BP | HP1120-0500-0001BR | HP1120-0500-0001BY | HP1120-0500-0001YB | HP1120-0500-0001YE | HP1120-0500-0001YP |
| 750 mm | HP1120-0750-0001BP | HP1120-0750-0001BR | HP1120-0750-0001BY | HP1120-0750-0001YB | HP1120-0750-0001YE | HP1120-0750-0001YP |
| 1000 mm | HP1120-1000-0001BP | HP1120-1000-0001BR | HP1120-1000-0001BY | HP1120-1000-0001YB | HP1120-1000-0001YE | HP1120-1000-0001YP |
| 1250 mm | HP1120-1250-0001BP | HP1120-1250-0001BR | HP1120-1250-0001BY | HP1120-1250-0001YB | HP1120-1250-0001YE | HP1120-1250-0001YP |
| 1500 mm | HP1120-1500-0001BP | HP1120-1500-0001BR | HP1120-1500-0001BY | HP1120-1500-0001YB | HP1120-1500-0001YE | HP1120-1500-0001YP |
| 1750 mm | HP1120-1750-0001BP | HP1120-1750-0001BR | HP1120-1750-0001BY | HP1120-1750-0001YB | HP1120-1750-0001YE | HP1120-1750-0001YP |
| 2000 mm | HP1120-2000-0001BP | HP1120-2000-0001BR | HP1120-2000-0001BY | HP1120-2000-0001YB | HP1120-2000-0001YE | HP1120-2000-0001YP |
| 250-2000 mm | HP1121-2000-0001BP | HP1121-2000-0001BR | HP1121-2000-0001BY | HP1121-2000-0001YB | HP1121-2000-0001YE | HP1121-2000-0001YP |

CORNER RAIL SETS (3R)

| | | | | | | |
|-----------------------------------|-------------------|-------------------|-------------------|-------------------|-------------------|-------------------|
| Corner rail 90°/135°: 500mm | - | - | - | - | HP1120-0500-C90YE | - |
| Corner rail 90°/135°: 750mm | - | - | - | - | HP1120-0750-C90YE | - |
| Corner rail 90°/135°: 1000mm | - | - | - | - | HP1120-1000-C90YE | - |
| Corner rail 90°/135°: 1250mm | - | - | - | - | HP1120-1250-C90YE | - |
| Corner rail 90°/135°: 1500 mm | HP1120-1500-C90BP | HP1120-1500-C90BR | HP1120-1500-C90BY | HP1120-1500-C90YB | HP1120-1500-C90YE | HP1120-1500-C90YP |
| Corner rail 90°/135°: 250-2000 mm | HP1121-2000-C45BP | HP1121-2000-C45BR | HP1121-2000-C45BY | HP1121-2000-C45YB | HP1121-2000-C45YE | HP1121-2000-C45YP |

160 <<< SPECSHEET

Boplan bv Head Office | Muizelstraat 12, 8560 Moorsele, Belgium | +32 56 20 64 20 | sales@boplan.com | www.boplan.com

DISCLAIMER: ALL PRODUCT SPECIFICATIONS AND DATA ARE SUBJECT TO CHANGE WITHOUT NOTICE TO IMPROVE RELIABILITY, FUNCTION OR DESIGN OR OTHERWISE.
© Boplan, the Boplan logo, Flex Impact, Extrilene, Ice Flex, Teddy Pro and RackBull are trademarks of Boplan bv. All other trademarks are property of their respective owners.

