

# TB 400 GRILL BARRIER

## SAFETY BARRIERS

Revision: 30 May 2024 5:04 PM  
Boplan reference: GB4...



### PRODUCT SPECIFICATIONS

APPLICATION	
Environment	Single tube traffic barrier protects people against the impact of forklifts and falling goods. Depending on the size of the (stacked) goods, one can opt for an arrangement with a centre distance between the rails of 275 mm or 550 mm. Intended for indoor use.
Impact performance at 90°	POST: 16100 Joule (Eq. to 5 ton - 9,1 km/h)
	RAIL: 20100 Joule (Eq. to 5 ton - 10,2 km/h)
MATERIAL	
Posts and rails	Extrilene® - UV resistant - Fire class E <sup>+</sup> - Non conductive - Impervious to most chemicals**
Caps	Sustainable elastomer
STANDARD COLOURS	
End post	Black RAL 9005
Mid post	Black RAL 9005
Impact tube	Yellow RAL 1003
Handrails	Yellow RAL 1003
BASEPLATES	
	Steel
Material	Steel 37
Coating	Lacquered
Colour	High gloss black

\*Classification according to EN 13501-1:2007 +A1:2009 - Fire classification of construction products and building elements.

\*\*Ask your local sales office for resistance to specific chemicals.

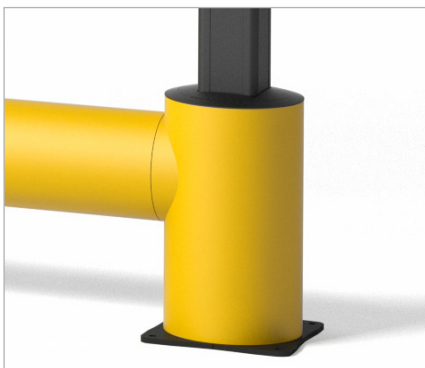

		FIXATIONS	
		ZC (Zinc coated)	SS (Stainless steel)
STANDARD	Concrete screw	 Ø12mm x 100mm	Not available
	Anchor rod (Chemical)	 M12 x 120mm + Chemical resin	M12 x 120mm + Chemical resin
ALTERNATIVES	Wedge anchor	 M12 x 120mm	M12 x 120mm
	Asphalt anchor	 Bolt M10 x 40mm + Screw Ø16mm	Not available



## FEATURES AND FUNCTIONALITY - TB 400 GRILL BARRIER

SIZE	
Height end posts	maximum 3075 mm
Height mid post	maximum 3075 mm
Profile section tubes	Ø200 mm (11 mm thick)
Profile section handrails	50 mm x 70 mm (6 mm thick)
Profile section end posts	Outer tube: Ø250 mm (11 mm thick) Inner profile: 112 mm x 112 mm (10 mm thick)
Profile section mid posts	Profile: 112 mm x 112 mm (10 mm thick)
Standard rail length (cc)	1350mm (center - center 1600mm)
Baseplate	End Post: 275 mm x 275 mm x (10 mm thick) Mid Post: 180 mm x 180 mm x (10 mm thick)

REQUIREMENTS	
Concrete quality	minimum C25/30
Concrete floor plate thickness (mm)	minimum 150 mm
Concrete slab dimension around posts (mm)	600 (h) x 600 (w) x 300 (d)
Operational temperature	-10°C up to +40°C
Water and humidity	<b>Steel</b> (standard): dry indoor use only.

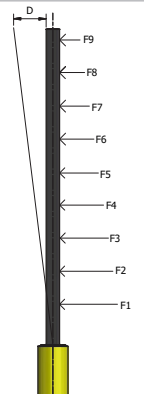

 <b>IMPACT LABEL FOR SAFETY BARRIERS</b>		
<b>BOPLAN TB 400 GRILL BARRIER</b>		
IMPACT RATING	45°	90°
E80 < 80 kJ		
E60 < 60 kJ		
E50 < 50 kJ		
E40 < 40 kJ		
E35 < 35 kJ		
E30 < 30 kJ		
E25 < 25 kJ	24,8 kJ	
E20 < 20 kJ		20,1 kJ
E15 < 15 kJ		
E10 < 10 kJ		
E5 < 5,0 kJ		
E2 < 2,5 kJ		
<b>TEST CONDITIONS</b> TEMPERATURE: 20°C / 68°F IMPACT HEIGHT: 300 mm / 11 3/4 Inch IMPACT ANGLE: 90° TEST FLOOR: CONCRETE SLAB C25/30 - 160 mm / 6 Inch MANUFACTURER ANCHOR PULL OUT: 7,9 kN	<b>TEST VEHICLE</b> WEIGHT: 2300 KG / 5070.63 lbs TYPE: COMMERCIAL FORK LIFT SIZE (L x W x h): 1890x1020x1970 mm / 74x40x78 Inch CONTACT AREA: STEEL BUMPER WIDTH: 600 mm / 24 Inch	<b>ACCREDITED TEST LABORATORY</b> 620 Route des Fromentaux 01500 Saint-Maurice-de-Rémens 01360 Bèlignieux France 
<b>SUCCESS CRITERIA</b> VEHICLE STOPPED - ASI (ACCELERATION SEVERITY INDEX) <0.5	<b>IL-GH-20230920</b>	

HOLDING POWER			
	Force*	Deflection**	
3075mm - 9R	F9 = 2600 N	825 mm	
2800mm - 8R	F8 = 2900 N	780 mm	
2525mm - 7R	F7 = 3300 N	730 mm	
2250mm - 6R	F6 = 3800 N	665 mm	
1975mm - 5R	F5 = 4500 N	585 mm	
1700mm - 4R	F4 = 5600 N	505 mm	
1425mm - 3R	F3 = 7300 N	405 mm	
1150mm - 2R	F2 = 10800 N	300 mm	
875mm - 1R	F1 = 19500 N	175 mm	

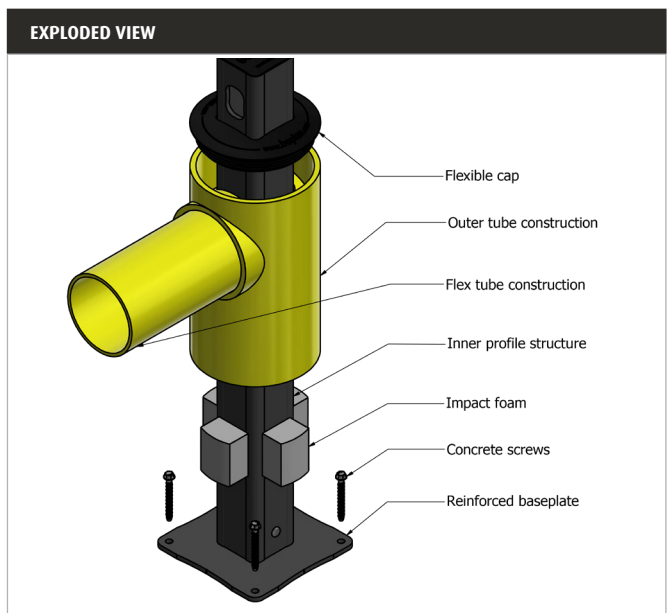
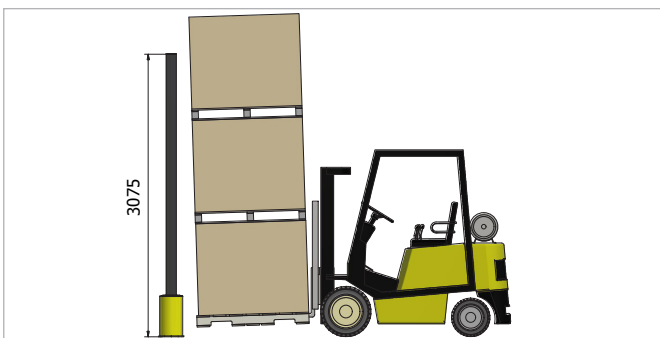

\* Force acting on the center of the hand rails (between posts)  
\*\* Deflection (D) measured on top side.

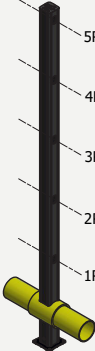

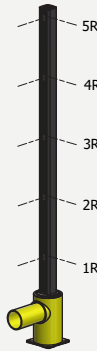
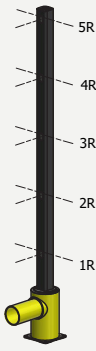
**REFERENCE LIST - TB 400 GRILL BARRIER**
**POSTS - 550 mm rail distance**

	End post	Mid post	Corner post 90° Up	Corner post 90° Down	T-end post (incl. caps)
3075mm - 5R	GB4550-3075-EPYE	GB4550-3075-MPYE	GB4550-3075-CPUYE	GB4550-3075-CPDYE	GB4550-3075-TPYE
2525mm - 4R	GB4550-2525-EPYE	GB4550-2525-MPYE	GB4550-2525-CPUYE	GB4550-2525-CPDYE	GB4550-2525-TPYE
1975mm - 3R	GB4550-1975-EPYE	GB4550-1975-MPYE	GB4550-1975-CPUYE	GB4550-1975-CPDYE	GB4550-1975-TPYE
1425mm - 2R	GB4550-1425-EPYE	GB4550-1425-MPYE	GB4550-1425-CPUYE	GB4550-1425-CPDYE	GB4550-1425-TPYE
					

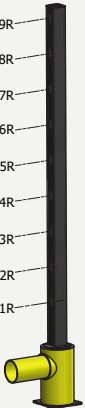
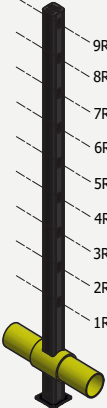
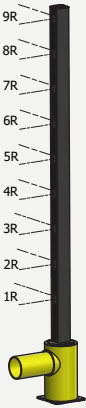
**POSTS - 275 mm rail distance**

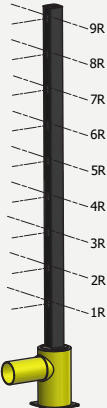
	End post	Mid post	Corner post 90° Up	Corner post 90° Down	T-end post (incl. caps)
3075mm - 9R	GB4275-3075-EPYE	GB4275-3075-MPYE	GB4275-3075-CPUYE	GB4275-3075-CPDYE	GB4275-3075-TPYE
2525mm - 7R	GB4275-2525-EPYE	GB4275-2525-MPYE	GB4275-2525-CPUYE	GB4275-2525-CPDYE	GB4275-2525-TPYE
1975mm - 5R	GB4275-1975-EPYE	GB4275-1975-MPYE	GB4275-1975-CPUYE	GB4275-1975-CPDYE	GB4275-1975-TPYE
1425mm - 3R	GB4275-1425-EPYE	GB4275-1425-MPYE	GB4275-1425-CPUYE	GB4275-1425-CPDYE	GB4275-1425-TPYE
					

**REFERENCE LIST - TB 400 GRILL BARRIER**

RAIL SETS									
	CC1000mm 750mm - YE	CC1200mm 950mm - YE	CC1400mm 1150mm - YE	CC1600mm 1350mm - YE	CC1800mm 1550mm - YE	CC2000mm 1750mm - YE	Short rail CC850-1599 - YE	Long rail CC1601-2000 - YE	Conn.tube Ø250 350mm - 90° - YE
9R	GBR900-0750-1000YE	GBR900-0950-1200YE	GBR900-1150-1400YE	GBR900-1350-1600YE	GBR900-1550-1800YE	GBR900-1750-2000YE	GBR909-1599-SRYE	GBR909-2000-LRYE	GBR900-0350-C259YE
7R	GBR700-0750-1000YE	GBR700-0950-1200YE	GBR700-1150-1400YE	GBR700-1350-1600YE	GBR700-1550-1800YE	GBR700-1750-2000YE	GBR709-1599-SRYE	GBR709-2000-LRYE	GBR700-0350-C259YE
5R	GBR500-0750-1000YE	GBR500-0950-1200YE	GBR500-1150-1400YE	GBR500-1350-1600YE	GBR500-1550-1800YE	GBR500-1750-2000YE	GBR509-1599-SRYE	GBR509-2000-LRYE	GBR500-0350-C259YE
4R	GBR400-0750-1000YE	GBR400-0950-1200YE	GBR400-1150-1400YE	GBR400-1350-1600YE	GBR400-1550-1800YE	GBR400-1750-2000YE	GBR409-1599-SRYE	GBR409-2000-LRYE	GBR400-0350-C259YE
3R	GBR300-0750-1000YE	GBR300-0950-1200YE	GBR300-1150-1400YE	GBR300-1350-1600YE	GBR300-1550-1800YE	GBR300-1750-2000YE	GBR309-1599-SRYE	GBR309-2000-LRYE	GBR300-0350-C259YE
2R	GBR200-0750-1000YE	GBR200-0950-1200YE	GBR200-1150-1400YE	GBR200-1350-1600YE	GBR200-1550-1800YE	GBR200-1750-2000YE	GBR209-1599-SRYE	GBR209-2000-LRYE	GBR200-0350-C259YE

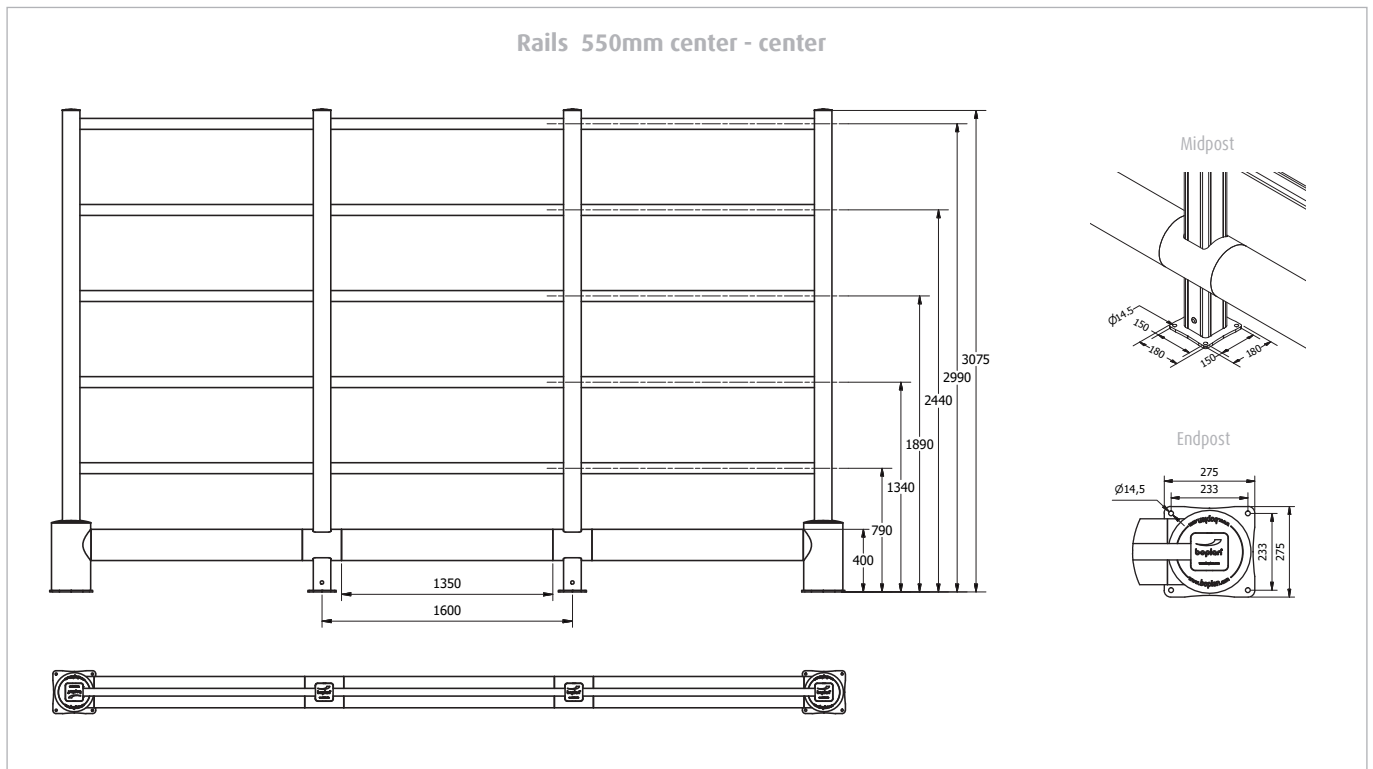
**TECHNICAL DRAWINGS - TB 400 GRILL BARRIER**

**TECHNICAL DRAWINGS - TB 400 GRILL BARRIER**

Rails 275 mm center - center

