

BO200F

BOLLARDS AND HEIGHT RESTRICTORS

Revision 03: 22 Maart 2023 4:22 PM
Boplan reference: BO200F0-...

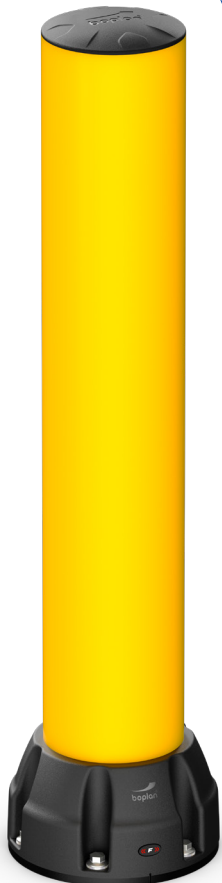

PRODUCT SPECIFICATIONS

APPLICATION	
Environment	Both robust and flexible, the BO200F with enforced base absorbs medium to heavy impacts in areas where high risks occurs: <ul style="list-style-type: none"> - Nearby machinery and infrastructure e.g. walls, accessways, and corners - Nearby heavy-duty vehicle traffic e.g. trucks, vans, and forklifts - Nearby people operating pushcarts, order picking vehicles and pallet trucks (due to buffering base protection) - Indoor and outdoor environments
Impact performance	16000 Joule (Eq. to 3,8 ton - 10,6 km/h)
MATERIAL	
Tube	Extrilene® - UV resistant - Fire class E ⁺ - Non conductive - Impervious to most chemicals**
Caps	Sustainable elastomer
Base Defender	Sustainable elastomer
Base Shield	Sustainable elastomer
COLOURS	
Bollard	Standard: Yellow RAL 1003 Also available in Black RAL 9005, Grey RAL 7042 and Red RAL 3020 (multicolour)
Base Defender	Standard: Black RAL 9005
OPTIONAL	
Base Shield	The optional Shield ensures additional protection to crucial internal components by deflecting ground level impacts. It will also increase display presence and hygiene by covering over the fixations.
Sign Mark 200	Sign board used to display important messages. It is designed for a perfect fit and signs can easily be replaced with just a click.
Sleeve	Polymer sleeve that can be slid over the bollard.
Stripes	Coloured reflective stripes providing a high level of visibility.
BASEPLATE	
	Zinc Coated Steel
Material	Steel 37
Coating	Electro plating + Lacquered
Colour	Mat black

*Classification according to EN 13501-1:2007 +A1:2009 - Fire classification of construction products and building elements.
**Ask your local sales office for resistance to specific chemicals.

		FIXATIONS	
		ZC (Zinc coated)	SS (Stainless steel)
STANDARD	Concrete screw	 Ø17mm x 130mm	Not available
ALTERNATIVE	Wegde anchor	 Ø18mm (M12) x 130mm	Not available



Base Defender with Impact Button

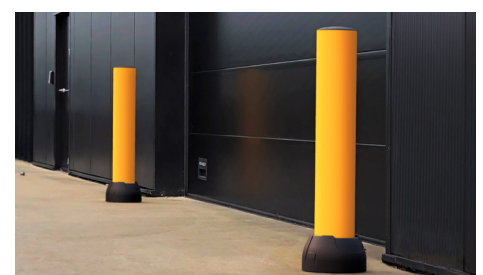



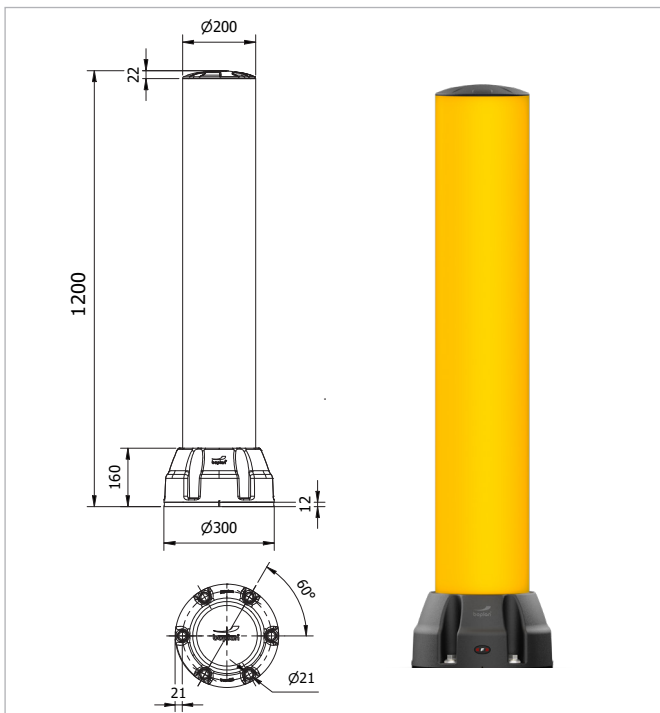

BO 200 Force with optional Base Shield.

FEATURES AND FUNCTIONALITY - B0200F

SIZE	
Height	750 mm 1000 mm 1200 mm 1201-1525 mm 1600-2000 mm 2100-2500 mm
Profile section post	Tube: Ø200 mm (11 mm thick)
Baseplate	Ø300 mm (12 mm thick)
Base Defender	Top: Ø200 mm Base: Ø300 mm Height: 150 mm
Base Shield (optional)	Top: Ø200 mm Base: Ø325 mm Height: 175 mm

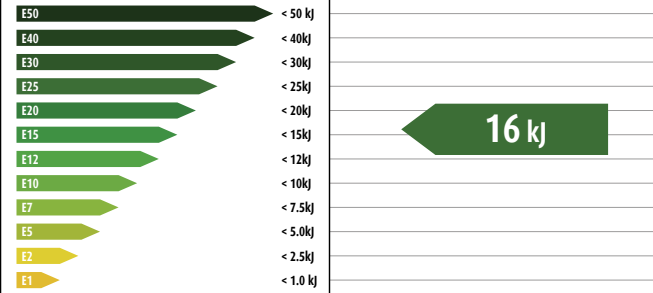

REQUIREMENTS	
Concrete quality	minimum C25/30
Concrete floor plate thickness (mm)	minimum 150
Concrete slab dimension around posts (mm)	900 (h) x 900 (w) x 700 (d)
Operational temperature	-10°C up to +40°C
Water and humidity	Zinc coated: Indoor and outdoor use in most environments.

boplan		IMPACT LABEL FOR SAFETY BARRIERS	
BOPLAN B0200F			
IMPACT RATING			
IMPACT RESULTS Deflection: At maximum impact energy	 $\alpha_i = 17.7^\circ$ $D_i = 350 \text{ mm} / 13.8 \text{ inch}$	SUCCESS CRITERIA VEHICLE STOPPED ASI (ACCELERATION SEVERITY INDEX) < 0.5	
TEST CONDITIONS TEMPERATURE: 20°C / 68°F IMPACT HEIGHT: 300 mm / 12 Inch → $D_i: 350 \text{ mm} / 13 \frac{3}{4} \text{ Inch} \rightarrow \alpha_i: 17.7^\circ$ IMPACT HEIGHT: 600 mm / 24 Inch → $D_i: 621 \text{ mm} / 24 \frac{1}{2} \text{ Inch} \rightarrow \alpha_i: 35.4^\circ$ TEST FLOOR: CONCRETE SLAB C25/30 - 150 mm / 6 Inch	BOPLAN TEST LAB Muizelstraat 12 8560 Moorsele Belgium   Approved by: TÜV NORD Systems		
TEST VEHICLE: TYPE: BOPLAN IMPACT TEST VEHICLE WEIGHT: 3775 Kg / 8322.45 lbs SIZE (L x W x H): 3100 x 1100 x 1150 mm / 122 x 43 1/4 x 45 1/4 Inch CONTACT AREA, STEEL BUMPER WIDTH: 1000 mm / 39 1/4 Inch	IL-B0200F-20230926		

FEATURES AND FUNCTIONALITY - B0200F

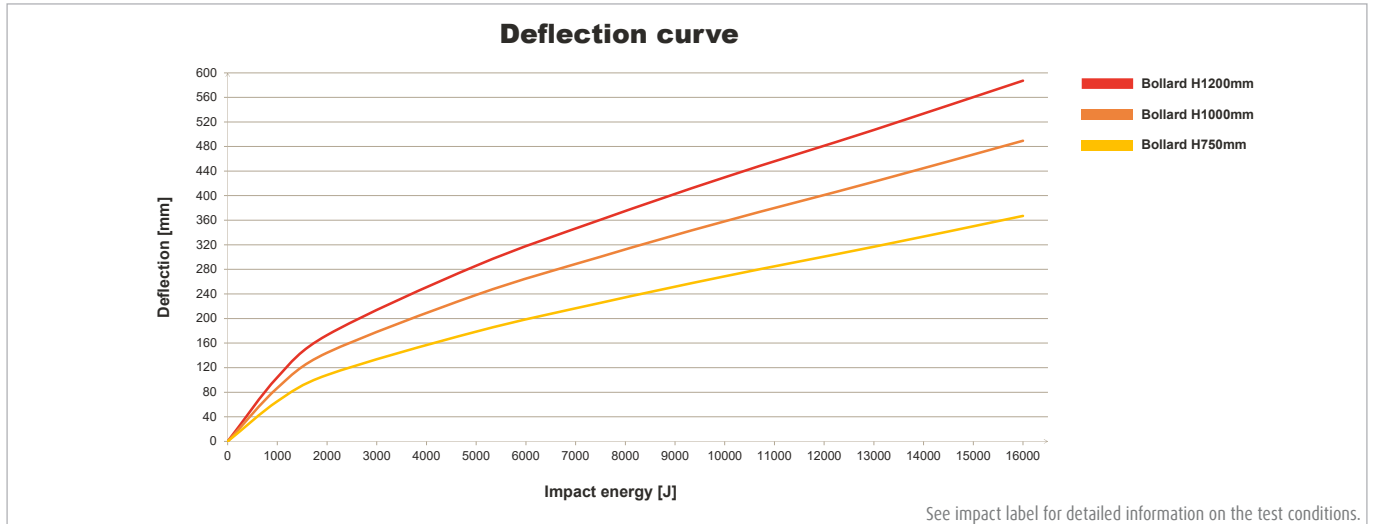

REFERENCE LIST - B0200F

Free standing Bollard 200 Force

	ZINC COATED (ZC) Non - countersunk	
	YELLOW	MULTICOLOUR 
1200 mm	B0200F0-1200-0001YEZ	B0200F0-1200-0001MCZ
1000 mm	B0200F0-1000-0001YEZ	B0200F0-1000-0001MCZ
750 mm	B0200F0-0750-0001YEZ	B0200F0-0750-0001MCZ
1201-1525	B0200F1-1525-0001YEZ	B0200F1-1525-0001MCZ
1600-2000	B0200F1-2000-0001YEZ	B0200F1-2000-0001MCZ
2100-2500	B0200F1-2500-0001YEZ	B0200F1-2500-0001MCZ

REFERENCE LIST - B0200F
Base Shield (OPTIONAL, NOT INCLUDED)

Ø200 mm

BP2000-0175-0001BL

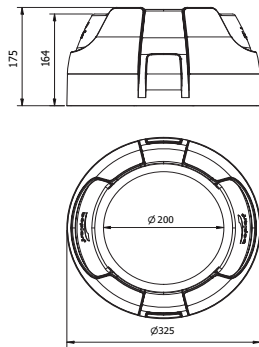

B0200F with optional Base Shield.

Sleeve (OPTIONAL, NOT INCLUDED)

YELLOW

 MULTIColour

1200 mm

BS2250-1005-0001YE

BS2250-1005-0001MC

1000 mm

BS2250-0905-0001YE

BS2250-0905-0001MC

750 mm

BS2250-0555-0001YE

BS2250-0555-0001MC

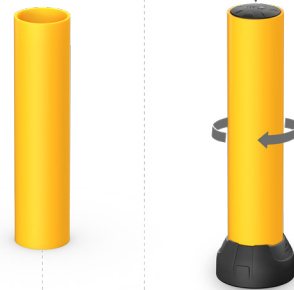
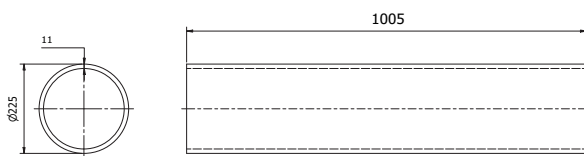

B0200F with optional Sleeve and Base Shield.

REFERENCE LIST - B0200F

STRIPES *			
	Black	White	Yellow
1 STRIPE	PA0300-0200-0001BL	PA0300-0200-0001WH	PA0300-0200-0001YE
2 STRIPES	PA0300-0200-0002BL	PA0300-0200-0002WH	PA0300-0200-0002YE
3 STRIPES	PA0300-0200-0003BL	PA0300-0200-0003WH	PA0300-0200-0003YE
			

* Remark: Stripes cannot be ordered separately

BOLLARD WITH STRIPES INCLUDED			
	Black	White	Yellow
1 STRIPE			
2 STRIPES			
3 STRIPES	B020F0-1200-3YEBLZ		
	