

TB 550

SAFETY BARRIERS

Revision: 30 May 2024 5:04 PM
Boplan reference: TB550...







PRODUCT SPECIFICATIONS

APPLICATION			
Environment	Protection of walls, machines and infrastructure from forklifts or other vehicles up to a height of 550mm. With reinforced mid post.		
Impact performance at 90°	POST: 13500 Joule (Eq. to 5 ton - 8,3 km/h)		
	RAIL: 18300 Joule (Eq. to 5 ton - 9,7 km/h)		
MATERIAL			
Posts and rails	Extrilene® - UV resistant - Fire class E ⁺ - Non conductive - Impervious to most chemicals ^{**}		
Caps	Sustainable elastomer		
STANDARD COLOURS			
End post	Yellow RAL 1003		
Mid post	Yellow RAL 1003		
Impact tube	Yellow RAL 1003		
BASEPLATES			
	Steel	Zinc Coated Steel	Stainless steel
Material	Steel 37	Steel 37	Stainless steel 304
Coating	Lacquered	Electroplated + Laquered	No lacquer / No coating
Colour	High gloss black	Mat black	Natural colour

*Classification according to EN 13501-1:2007 +A1:2009 - Fire classification of construction products and building elements.

**Ask your local sales office for resistance to specific chemicals.

		FIXATIONS	
		ZC (Zinc coated)	SS (Stainless steel)
STANDARD	Wedge anchor	 M12 x 120mm	M12 x 120mm
	Anchor rod (Chemical)	 M12 x 120mm + Chemical resin	M12 x 120mm + Chemical resin
ALTERNATIVES	Concrete screw	 Ø12mm x 100mm	Not available
	Asphalt anchor	 Bolt M10 x 40mm + Screw Ø16mm	Not available
	Spit anchor	 Bolt M12 x 100mm + Plug Ø20mm	Not available

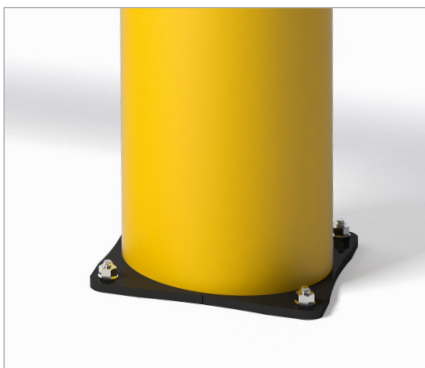

FEATURES AND FUNCTIONALITY - TB 550

SIZE	
Height end posts	600 mm
Height mid post	560 mm
Profile section tubes	Ø200 mm (11 mm thick)
Profile section end posts	Outer tube: Ø250 mm (11 mm thick) Inner profile: 112mm x 112 mm (10 mm thick)
Profile section mid posts	Outer tube: Ø164 mm (8 mm thick) Inner profile: 112 mm x 112 mm (10 mm thick)
Standard rail length	1350 mm (other sizes: 750 mm - 1750 mm)
Baseplate	End Post: 275 mm x 275 mm (10mm thick) Mid Post: 180 mm x 180 mm (10mm thick)

REQUIREMENTS	
Concrete quality	minimum C25/30
Concrete floor plate thickness	minimum 150 mm
Concrete slab dimension around posts (mm)	600 (h) x 600 (w) x 500 (d)
Operational temperature	-10°C up to +40°C
Water and humidity	Steel (standard): dry indoor use only. Zinc coated: outdoor use in most environments. Stainless Steel: outdoor use or frequent exposure to water and humidity.

boplan **IMPACT LABEL FOR SAFETY BARRIERS**

BOPLAN TB 550		
IMPACT RATING	45°	90°
E80 > 80 kJ		
E60 > 60 kJ		
E50 > 50 kJ		
E40 > 40 kJ		
E35 > 35 kJ		
E30 > 30 kJ	25,9 kJ	
E25 > 25 kJ		
E20 > 20 kJ		18,3 kJ
E15 > 15 kJ		
E10 > 10 kJ		
E5 > 5,0 kJ		
E2 > 2,5 kJ		

TEST CONDITIONS TEMPERATURE: 20°C IMPACT HEIGHT: 460 mm TEST FLOOR: CONCRETE C25/30 - 160 mm MANUFACTURER ANCHOR PULL OUT: 7,9 kN	TEST VEHICLE WEIGHT: 2300 KG TYPE: COMMERCIAL FORK LIFT SIZE (L x W x h): 1890 x 1020 x 1970 mm CONTACT AREA: STEEL BUMPER WIDTH: 600 mm	ACCREDITED TEST LABORATORY 620 Route des Fromentaux 01500 Saint-Maurice-de-Rémens 01360 Bèlignieux France
--	---	--

SUCCESS CRITERIA VEHICLE STOPPED - ASI (ACCELERATION SEVERITY INDEX) < 0.5

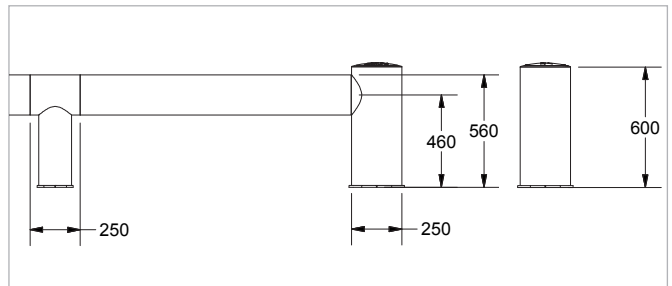
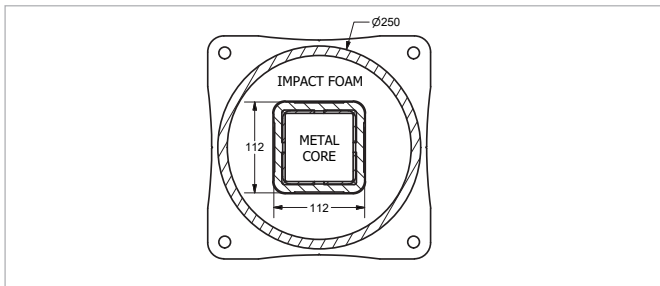
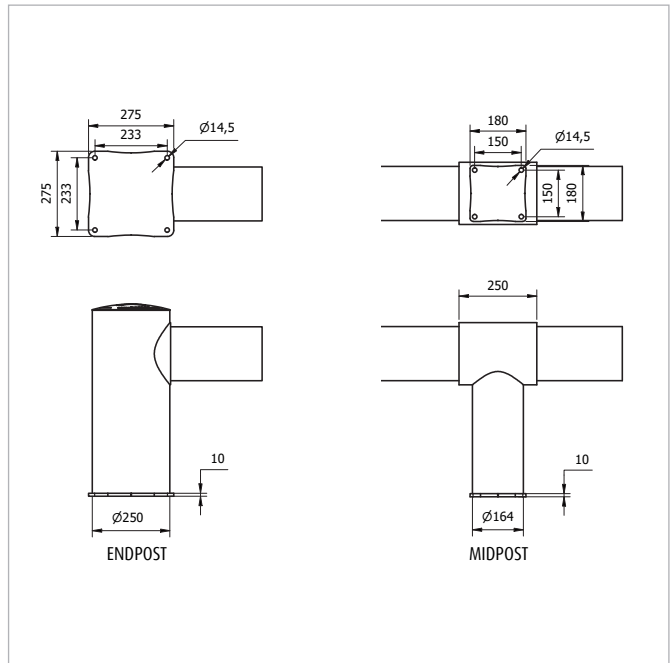

REFERENCE LIST - TB 550

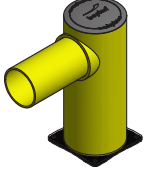
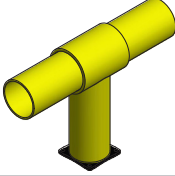
POSTS		
End post End post - ZC End post - SS	TB5500-0001-EPYE TB5500-0001-EPYEZ TB5500-0001-EPYES	
Mid post Mid post - ZC Mid post - SS	TB5500-0001-MPYE TB5500-0001-MPYEZ TB5500-0001-MPYES	

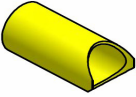
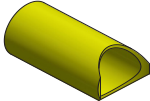
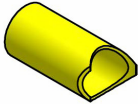
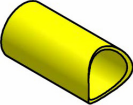
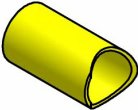
CURVES		
Conn.tube Ø200 Curve 350mm - YE	TB5500-0350-C200YE	
Conn.tube Ø200 - 45° Curve 350mm - YE	TB5500-0350-C204YE	
Conn.tube Ø200 - 90° Curve 350mm - YE	TB5500-0350-C209YE	
Conn.tube Ø250 Curve 350mm - YE	TB5500-0350-C250YE	
Conn.tube Ø250 - 90° Curve 350mm - YE	TB5500-0350-C259YE	

RAIL SETS			
	Tube length (A)	CC length (B)	Reference
Standard rail	750 mm	1000 mm	TB5500-0750-1000YE
Standard rail	950 mm	1200 mm	TB5500-0950-1200YE
Standard rail	1150 mm	1400 mm	TB5500-1150-1400YE
Standard rail	1350 mm	1600 mm	TB5500-1350-1600YE
Standard rail	1550 mm	1800 mm*	TB5500-1550-1800YE
Standard rail	1750 mm	2000 mm*	TB5500-1750-2000YE
Short rail	600-1349 mm	850-1599 mm	TB5509-1599-SRYE
Long rail	1351-1749 mm	1601-2000 mm*	TB5509-2000-LRYE

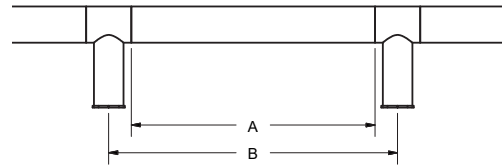

* The impact performance has not been tested for tube lengths > 1600 mm. Only use these lengths for non - critical applications.

REFERENCE LIST - TB 550

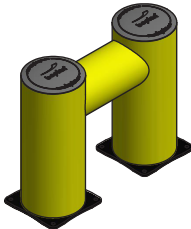
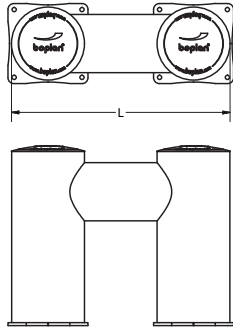
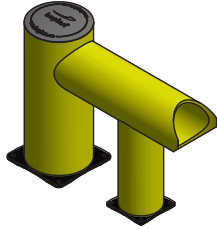
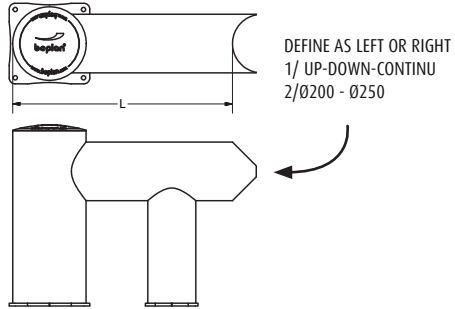
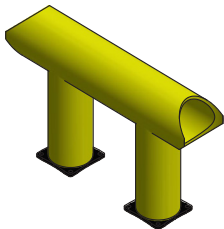
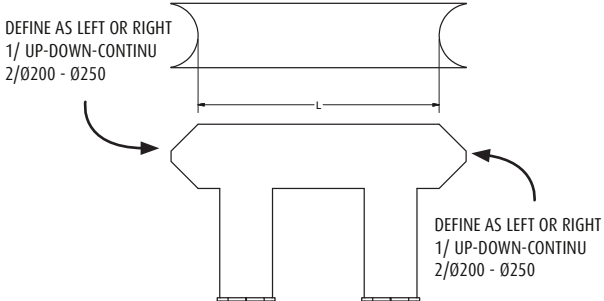
FIXED UNITS					
TYPE	LENGTH	BASE	REFERENCE YE		
no curves	750 mm	Steel ZC SS	TB5500-0750-FUYE TB5500-0750-FUYEZ TB5500-0750-FUYES		
	751-1750 mm	Steel ZC SS	TB5501-1750-FUYE TB5501-1750-FUYEZ TB5501-1750-FUYES		
1 curve	750 mm	Steel ZC SS	TB5500-0750-FU1CYE TB5500-0750-FU1CYEZ TB5500-0750-FU1CYES		
	751-1750 mm	Steel ZC SS	TB5501-1750-FU1CYE TB5501-1750-FU1CYEZ TB5501-1750-FU1CYES		
2 curves	750 mm	Steel ZC SS	TB5500-0750-FU2CYE TB5500-0750-FU2CYEZ TB5500-0750-FU2CYES		
	751-1750 mm	Steel ZC SS	TB5501-1750-FU2CYE TB5501-1750-FU2CYEZ TB5501-1750-FU2CYES		