

# FLIP 120M BOPLAN KICK RAILS AND WHEEL CHOCKS

Revision: 14 December 2023 8:18 AM  
Boplan reference: PL1200





## PRODUCT SPECIFICATIONS

APPLICATION	
Environment	<b>Ground level protection</b> - Wall protection (refrigerator walls, decorative walls, sandwich panels) - Wheel guide for pallet trucks or trolleys in busy traffic lanes - Protection of machines and infrastructures - Indoor and outdoor use - Food industry
MATERIAL	
Connection pieces / Rails	Novilene® - UV resistant - Fire class E <sup>*</sup> - Non conductive - Impervious to most chemicals <sup>***</sup>
Cap / Seal	Rubber - UV resistant - Fire class E <sup>*</sup> - Non conductive - Impervious to most chemicals <sup>**</sup>
STANDARD COLORS	
Connection pieces	Black
Rail	Yellow - Black / Black - Yellow (Bi-color)

\*Classification according to EN 13501-1:2007 +A1:2009 - Fire classification of construction products and building elements.

\*\*Ask your local sales office for resistance to specific chemicals.

		FIXATIONS		
			ZC (Zinc coated)	SS (Stainless steel)
STANDARD	Concrete screw		Ø12mm x 100mm	Not available
	Anchor rod (Chemical)		M12 x 120mm + Chemical resin	M12 x 120mm + Chemical resin
ALTERNATIVES	Wedge Anchor		M12 x 120mm	Not available
	Asphalt anchor		Bolt M10 x 40mm + Screw Ø16mm	Not available

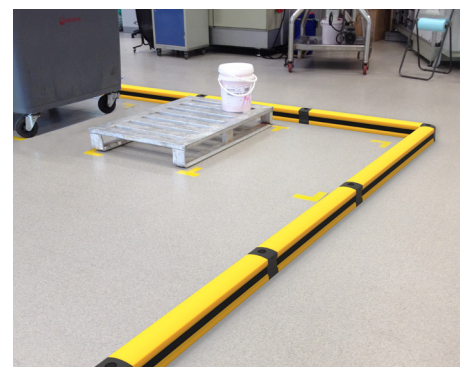
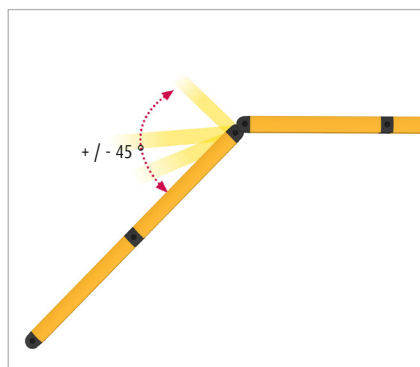
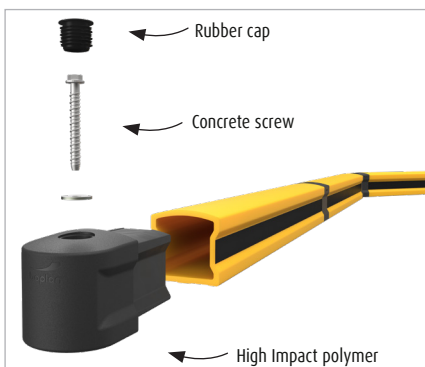
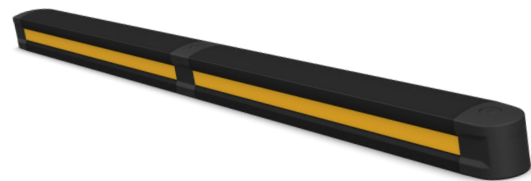

**FEATURES AND FUNCTIONALITY - FLIP 120M**

BOPLAN FLIP 120 M		
<b>IMPACT RATING</b>	45°	90° PAS 13:2017 compliant
E80 < 80 kJ		
E60 < 60 kJ		
E50 < 50 kJ		
E40 < 40 kJ		
E35 < 35 kJ		
E30 < 30 kJ		
E25 < 25 kJ		
E20 < 20 kJ		
E15 < 15 kJ		
E10 < 10 kJ		
E5 < 5,0 kJ	3.6kJ	2.6kJ
E2 < 2,5 kJ		
<b>DEFLECTION</b> At maximum impact energy	D = NA	D = 201 mm
<b>TEST CONDITIONS</b> TEMPERATURE: 20°C IMPACT ANGLE: 90° - IMPACT HEIGHT: 75 mm STANDARD RAIL LENGTH: 1400 mm TEST FLOOR: CONCRETE C25/30 - 160 mm MANUFACTURER ANCHOR PULL OUT: 12.6 kN	<b>TEST VEHICLE</b> WEIGHT: 3762 KG TYPE: BOPLAN IMPACT TEST VEHICLE SIZE (L x W x h): 3100 x 1100 x 1150 mm CONTACT AREA: STEEL BUMPER WIDTH: 1000 mm	<b>BOPLAN TEST LAB</b> Muiselstraat 12 8560 Moorsele Belgium 
<b>SUCCESS CRITERIA</b> VEHICLE STOPPED - ASI (ACCELERATION SEVERITY INDEX) <0.5		

SIZE	
Height	120 mm
Profile section	120 mm x 120 mm (10 mm thick)
Standard rail length	see next page

REQUIREMENTS	
Compatibility	Below TB 400 / TB400 Plus / HP Plus - ...
Floor	Industrial concrete, flat surface
Concrete quality	minimum C25/30
Concrete floor plate thickness (mm)	minimum 150
Operational temperature	-10°C up to +40°C
Water and humidity	<b>Zinc coated fixations:</b> indoor and outdoor use in most environments

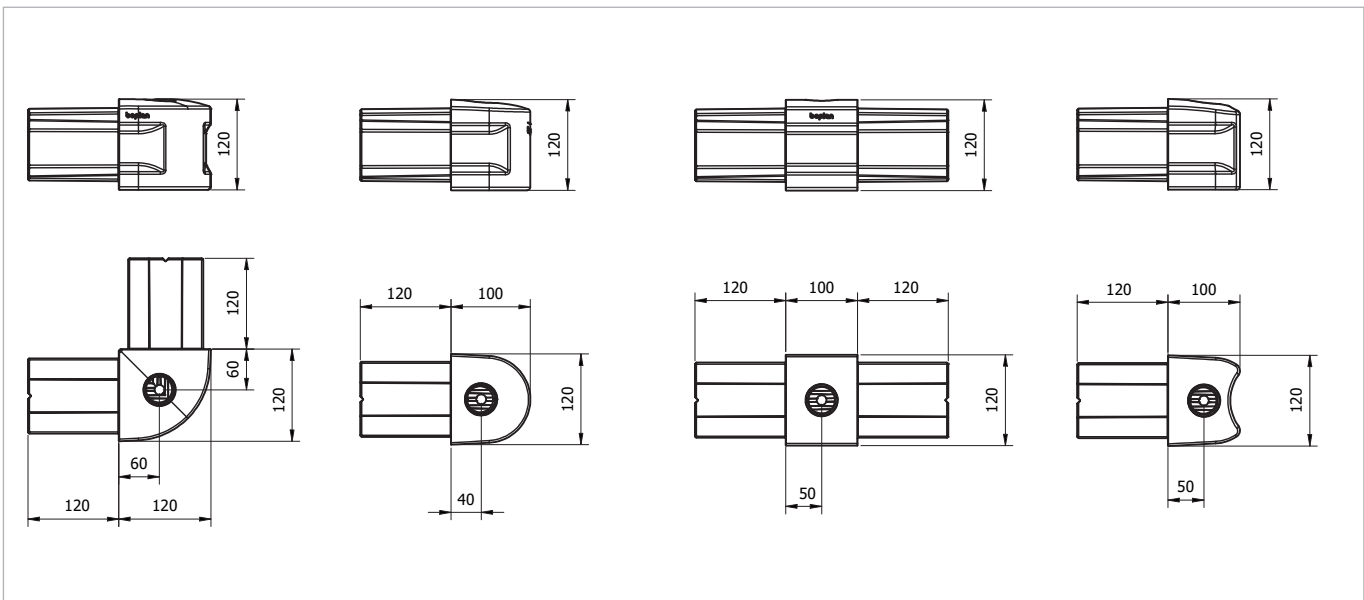

**REFERENCE LIST - FLIP 120M**

CONNECTION PIECES		
Endpost	PL1200-0001-EPBL	
Midpost	PL1200-0001-MPBL	
Corner post 90°	PL1200-0001-CPBL	
Universal corner post	PL1200-0001-UCBL	

RAIL SETS				
	Rail length	CC length	Reference Y/B	Reference B/Y
Standard rail	400 mm	500 mm	PL1200-0400-0001YB	PL1200-0400-0001BY
Standard rail	600 mm	700 mm	PL1200-0600-0001YB	PL1200-0600-0001BY
Standard rail	800 mm	900 mm	PL1200-0800-0001YB	PL1200-0800-0001BY
Standard rail	1000 mm	1100 mm	PL1200-1000-0001YB	PL1200-1000-0001BY
Standard rail	1200 mm	1300 mm	PL1200-1200-0001YB	PL1200-1200-0001BY
Standard rail	1400 mm	1500 mm	PL1200-1400-0001YB	PL1200-1400-0001BY
Standard rail	1600 mm	1700 mm	PL1200-1600-0001YB	PL1200-1600-0001BY
Standard rail	1800 mm	1900 mm	PL1200-1800-0001YB	PL1200-1800-0001BY
Non Std rail	300 - 1399 mm	400 - 1499 mm	PL1201-1499-0001YB	PL1201-1499-0001BY
Non Std rail	1401-1799 mm	1501 - 1899 mm	PL1201-1899-0001YB	PL1201-1899-0001BY

The impact performance has not been tested for tube lengths >1400 mm.  
Only use longer lengths for non - critical applications.

