

# TB 260

## SAFETY BARRIERS

Revision: 29 January 2026 9:04 AM  
Boplan reference: TB260...



### PRODUCT SPECIFICATIONS

APPLICATION			
Environment	The TB 260 is ideal for protecting against damage caused by forklift manoeuvres. The lower tube prevents goods or pallets sliding under the barriers and hitting pedestrians or causing damage to machines or equipment.		
Impact performance at 90°	POST: 12000 Joule (Eq. to 5 ton - 5 mph)		
	RAIL: 21200 Joule (Eq. to 5 ton - 6.5 mph)		
MATERIAL			
Posts and rails	Extrilene - UV resistant - Fire class E° - Non conductive - Impervious to most chemicals**		
Caps	Sustainable elastomer		
STANDARD COLOURS			
End post	Yellow RAL 1003		
Mid post	Yellow RAL 1003		
Impact Tube	Yellow RAL 1003		
BASEPLATES			
	Steel	Zinc Coated Steel	Stainless Steel
Material	Steel 37	Steel 37	Stainless steel 304
Coating	Lacquered	Electroplated + Laquered	No lacquer / No coating
Colour	High gloss black	Mat black	Natural colour

\*Classification according to EN 13501-1:2007 +A1:2009 - Fire classification of construction products and building elements.  
\*\*Ask your local sales office for resistance to specific chemicals.

FIXATIONS				
			ZC (Zinc coated)	SS (Stainless steel)
STANDARD	Wedge anchor		1/2 in x 4 1/2 in	Not available
	Wedge anchor		M12 x 120 mm	M12 x 120 mm
ALTERNATIVES	Anchor rod (Chemical)		M12 x 120 mm + Chemical resin	M12 x 120 mm + Chemical resin
	Asphalt anchor		Bolt M10 x 40 mm + Screw Ø16 mm	Not available
	Spit anchor		Bolt M12 x 100 mm + Plug Ø20 mm	Not available

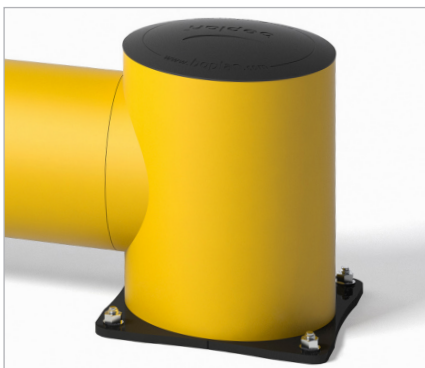

**FEATURES AND FUNCTIONALITY - TB 260**

SIZE	
Height end posts	11 4/5 in
Height mid post	10 1/3 in
Profile section tubes	Ø8 in (2/5 in thick)
Profile section end posts	Outer tube: Ø10 in (2/5 in thick) Inner profile: 4 2/5 x 4 2/5 in (1/3 in thick)
Profile section mid posts	Profile: 4 2/5 x 4 2/5 in (1/3 in thick)
Standard rail length	CC60 in (Tube length - 50 in)
Baseplate	End Post: 10 4/5 x 10 4/5 in (1/3 in thick) Mid Post: 7 x 7 in (1/3 in thick)

REQUIREMENTS	
Concrete quality	minimum 4000 PSI (C25/30)
Concrete floor plate thickness	minimum 6 in
Concrete slab dimension around posts (in)	23 2/3 (h) x 23 2/3 (w) x 19 3/4 (d)
Operational temperature	14°F up to 104°F
Water and humidity	<b>Steel (standard):</b> dry indoor use only. <b>Zinc coated:</b> outdoor use in most environments. <b>Stainless steel:</b> outdoor use or frequent exposure to water and humidity.

**boplan** **IMPACT LABEL FOR SAFETY BARRIERS**

**BOPLAN TB 260**

IMPACT RATING	45°	90°
E80 < 80 kJ		
E60 < 60 kJ		
E50 < 50 kJ		
E40 < 40 kJ		
E35 < 35 kJ	<b>30,0 kJ</b>	
E30 < 30 kJ		
E25 < 25 kJ		<b>21,2 kJ</b>
E20 < 20 kJ		
E15 < 15 kJ		
E10 < 10 kJ		
E5 < 5,0 kJ		
E2 < 2,5 kJ		

TEST CONDITIONS	TEST VEHICLE	ACCREDITED TEST LABORATORY
TEMPERATURE: 20°C / 68°F IMPACT HEIGHT: 160 mm / 6 1/4 Inch IMPACT ANGLE: 90° TEST FLOOR: CONCRETE SLAB C25/30 - 160 mm / 6 Inch MANUFACTURER ANCHOR PULL OUT: 7,9 kN	WEIGHT: 2300 KG / 5070.63 lbs TYPE: COMMERCIAL FORK LIFT SIZE (L x W x h): 1890x1020x1970 mm / 74x40x78 Inch CONTACT AREA: STEEL BUMPER WIDTH: 600 mm / 24 Inch	620 Route des Fromentaux 01500 Saint-Maurice-de-Rémens 01360 Bèlignieux France

**SUCCESS CRITERIA** VEHICLE STOPPED - ASI (ACCELERATION SEVERITY INDEX) < 0.5 **IL-TB260-20250103**

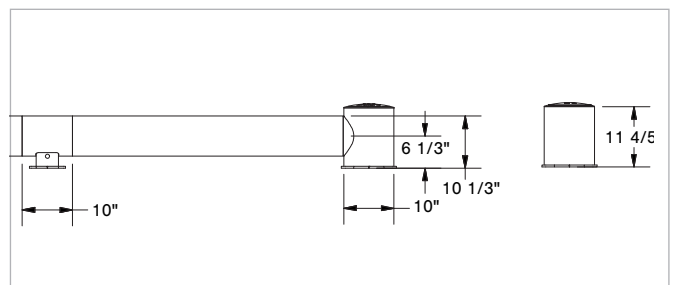
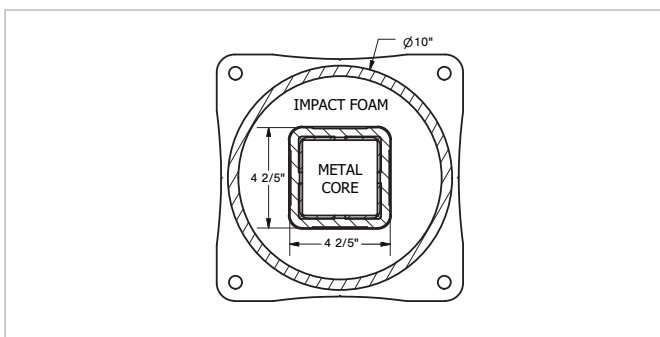
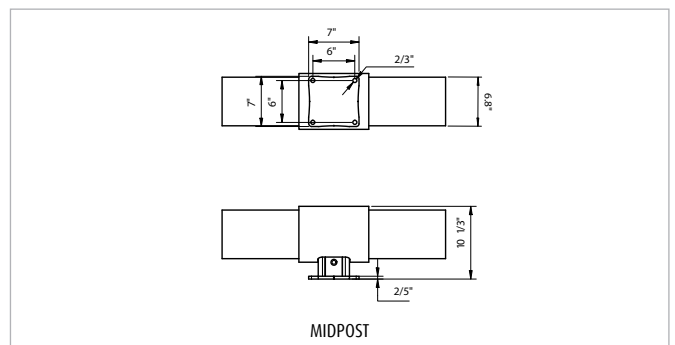
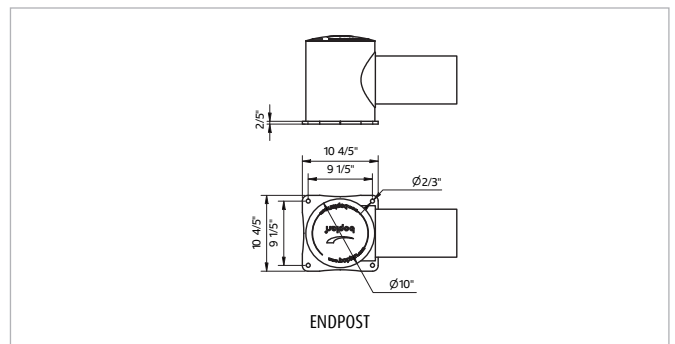

**REFERENCE LIST - TB 260**

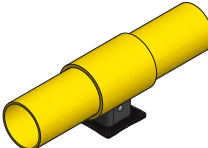
POSTS		
End post End post - ZC End post - SS	TB2600-0001-EPYE TB2600-0001-EPYEZ TB2600-0001-EPYES	
Mid post Mid post - ZC Mid post - SS	TB2600-0001-MPYE TB2600-0001-MPYEZ TB2600-0001-MPYES	

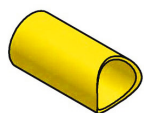
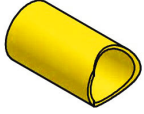
CURVES		
Conn.tube Ø10 in Curve 14 in - YE	TB2600-0014-C100YE	
Conn.tube Ø10 in - 90° Curve 14 in - YE	TB2600-0014-C109YE	

RAIL SETS			
	Tube length (A)	CC length (B)	Reference
Standard rail	26 in	36 in	TB2600-0665-0915YE
Standard rail	32 in	42 in	TB2600-0817-1067YE
Standard rail	38 in	48 in	TB2600-0970-1220YE
Standard rail	50 in	60 in	TB2600-1275-1525YE
Standard rail	62 in	72 in*	TB2600-1578-1828YE
Standard rail	68 in	78 in*	TB2600-1730-1980YE
Short rail	26 - 38 in	36 - 48 in	TB2609-0048-SRYE
Long rail	50 - 62 in	60 - 72 in*	TB2609-0072-LRYE

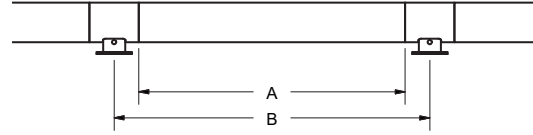

\* The impact performance has not been tested for tube lengths > 63 in.  
Only use these lengths for non - critical applications.

**REFERENCE LIST - TB 260**

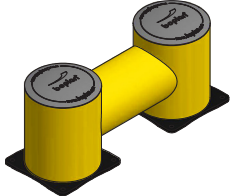
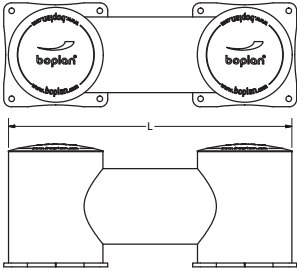
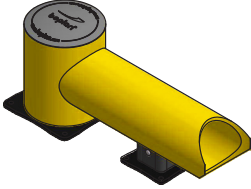
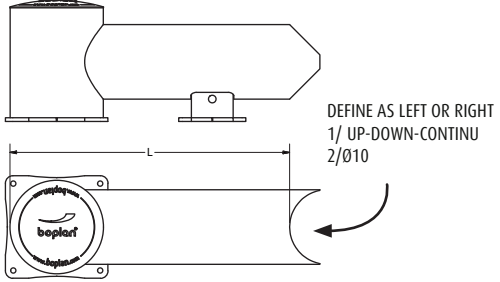
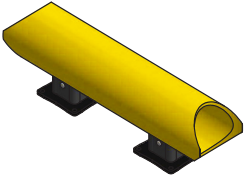
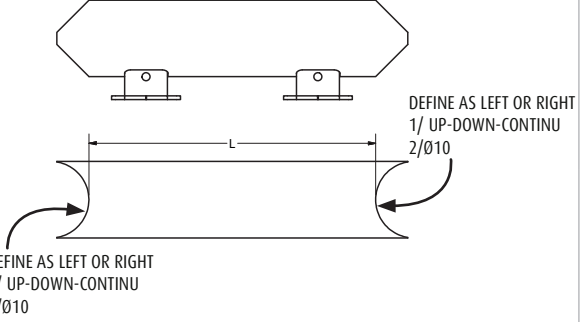
FIXED UNITS					
TYPE	LENGTH	BASE	REFERENCE YE		
No curves	30 in	Steel ZC SS	TB2600-0750-FUYE TB2600-0750-FUYEZ TB2600-0750-FUYES		
	30 - 68 in	Steel ZC SS	TB2601-1750-FUYE TB2601-1750-FUYEZ TB2601-1750-FUYES		
1 curve	30 in	Steel ZC SS	TB2600-0750-FU1CYE TB2600-0750-FU1CYEZ TB2600-0750-FU1CYES		
	30 - 68 in	Steel ZC SS	TB2601-1750-1CYE TB2601-1750-1CYEZ TB2601-1750-1CYES		
2 curves	30 in	Steel ZC SS	TB2600-0750-FU2CYE TB2600-0750-FU2CYEZ TB2600-0750-FU2CYES		
	30 - 68 in	Steel ZC SS	TB2601-1750-FU2CYE TB2601-1750-FU2CYEZ TB2601-1750-FU2CYES		