

# TB 400 DOUBLE GRILL BARRIER

## SAFETY BARRIERS

Revision: 20 April 2026 9:31 AM  
Boplan reference: GD4...



### PRODUCT SPECIFICATIONS

APPLICATION	
Environment	Extremely robust, double traffic barrier for collision protection against heavy vehicles and (falling) goods. The TB double-tube guardrail offers pedestrians increased safety in storage areas with a lot of forklift traffic. Depending on the size of the (stacked) goods, one can opt for an arrangement with a centre distance between the rails of 275 mm or 550 mm. Intended for indoor use.
MATERIAL	
Posts and rails	Extrilene® - UV resistant - Fire class E <sup>+</sup> - Non conductive - Impervious to most chemicals <sup>**</sup>
STANDARD COLOURS	
End post	Black RAL 9005
Mid post	Black RAL 9005
Impact tube	Yellow RAL 1003
Handrails	Yellow RAL 1003
BASEPLATES	
	Steel
Material	Steel 37
Coating	Lacquered
Colour	High gloss black

\*Classification according to EN 13501-1:2007 +A1:2009 - Fire classification of construction products and building elements.

\*\*Ask your local sales office for resistance to specific chemicals.

		FIXATIONS	
		ZC (Zinc coated)	SS (Stainless steel)
STANDARD	Concrete screw		Ø17mm x 130mm
ALTERNATIVES	Anchor rod (Chemical)		M16 x 120mm + Chemical resin
	Wedge anchor		M12 x 120mm



**REFERENCE LIST - TB 400 DOUBLE GRILL BARRIER**



SIZE	
Height end posts	maximum 3350 mm
Height mid post	maximum 3350 mm
Profile section tubes	Ø200 mm (11 mm thick)
Profile section handrails	50 mm x 70 mm (6 mm thick)
Profile section end posts	Outer tube: Ø250 mm (11 mm thick) Inner profile: 112 mm x 112 mm (10 mm thick)
Profile section mid posts	Profile: 112 mm x 112 mm (10 mm thick)
Standard rail length (cc)	1350mm (center - center 1600mm)
Baseplate	End Post: 275 mm x 320 mm x (12 mm thick) Mid Post: 220 mm x 300 mm x (12 mm thick)

REQUIREMENTS	
Concrete quality	minimum C25/30
Concrete floor plate thickness (mm)	minimum 150 mm
Concrete slab dimension around posts (mm)	800 (h) x 800 (w) x 600 (d)
Operational temperature	-10°C up to +40°C
Water and humidity	<b>Steel</b> (standard): dry indoor use only.



### IMPACT LABEL FOR SAFETY BARRIERS

BOPLAN TB 400 DOUBLE GRILL BARRIER		
IMPACT RATING	45°	90°
E80 < 80 kJ		
E60 < 60 kJ	<b>55,3 kJ</b>	
E50 < 50 kJ		
E40 < 40 kJ		<b>39,1 kJ</b>
E35 < 35 kJ		
E30 < 30 kJ		
E25 < 25 kJ		
E20 < 20 kJ		
E15 < 15 kJ		
E10 < 10 kJ		
E5 < 5,0 kJ		
E2 < 2,5 kJ		

<b>TEST CONDITIONS</b> TEMPERATURE: 20°C / 68°F IMPACT HEIGHT: 650 mm / 25 5/8 Inch IMPACT ANGLE: 90° TEST FLOOR: CONCRETE SLAB C25/30 - 160 mm / 6 inch MANUFACTURER ANCHOR PULL OUT: 17 kN	<b>TEST VEHICLE</b>  WEIGHT: 2300 KG / 5070.63 lbs TYPE: COMMERCIAL FORK LIFT SIZE (L x W x h): 1890x1020x1970 mm / 74x40x78 Inch CONTACT AREA: STEEL BUMPER WIDTH: 600 mm / 24 inch	<b>ACCREDITED TEST LABORATORY</b>  620 Route des Fromentaux 01500 Saint-Maurice-de-Rémens 01360 Bèlignieux France <b>IL-GD-20230920</b>
<b>SUCCESS CRITERIA</b> VEHICLE STOPPED - ASI (ACCELERATION SEVERITY INDEX) < 0.5		

HOLDING POWER		
	Force*	Deflection**
3350mm - 9R	F9 = 2800 N	750 mm
3075mm - 8R	F8 = 3200 N	725 mm
2800mm - 7R	F7 = 3600 N	655 mm
2525mm - 6R	F6 = 4100 N	625 mm
2250mm - 5R	F5 = 5000 N	530 mm
1975mm - 4R	F4 = 6200 N	450 mm
1700mm - 3R	F3 = 8400 N	370 mm
1425mm - 2R	F2 = 13000 N	260 mm
1065mm - 1R	F1 = 21000 N	100 mm

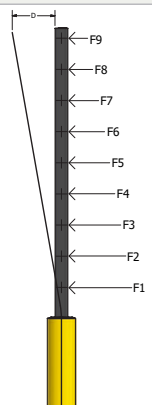

\* Force acting on the center of the hand rails (between posts)  
 \*\* Deflection (D) measured on top side.

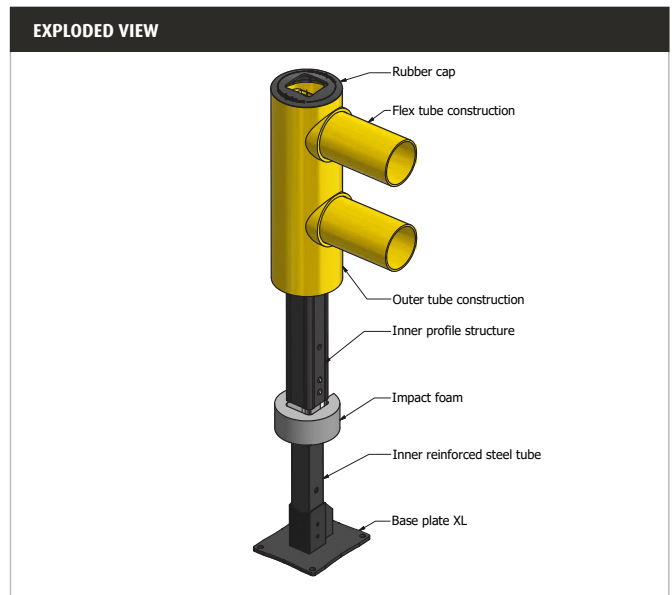

**REFERENCE LIST - TB 400 DOUBLE GRILL BARRIER**
**POSTS - 550 mm rail distance**

	End post Left	End post Right	Mid post	Corner post 90° Left - Up	Corner post 90° Left - Down	Corner post 90° Right - Up	Corner post 90° Right - Down	T-end post - Left (incl. caps)	T-end post - Right (incl. caps)
3350mm - 5R	GD4550-3350-EPLYE	GD4550-3350-EPRYE	GD4550-3350-MPYE	GD4550-3350-CPULYE	GD4550-3350-CPDLYE	GD4550-3350-CPURYE	GD4550-3350-CPDRYE	GD4550-3350-TPLYE	GD4550-3350-TPRYE
2800mm - 4R	GD4550-2800-EPLYE	GD4550-2800-EPRYE	GD4550-2800-MPYE	GD4550-2800-CPULYE	GD4550-2800-CPDLYE	GD4550-2800-CPURYE	GD4550-2800-CPDRYE	GD4550-2800-TPLYE	GD4550-2800-TPRYE
2250mm - 3R	GD4550-2250-EPLYE	GD4550-2250-EPRYE	GD4550-2250-MPYE	GD4550-2250-CPULYE	GD4550-2250-CPDLYE	GD4550-2250-CPURYE	GD4550-2250-CPDRYE	GD4550-2250-TPLYE	GD4550-2250-TPRYE
1700mm - 2R	GD4550-1700-EPLYE	GD4550-1700-EPRYE	GD4550-1700-MPYE	GD4550-1700-CPULYE	GD4550-1700-CPDLYE	GD4550-1700-CPURYE	GD4550-1700-CPDRYE	GD4550-1700-TPLYE	GD4550-1700-TPRYE



**POSTS - 275 mm rail distance**

	End post Left	End post Right	Mid post	Corner post 90° Left - Up	Corner post 90° Left - Down	Corner post 90° Right - Up	Corner post 90° Right - Down	T-end post - Left (incl. caps)	T-end post - Right (incl. caps)
3350mm - 9R	GD4275-3350-EPLYE	GD4275-3350-EPRYE	GD4275-3350-MPYE	GD4275-3350-CPULYE	GD4275-3350-CPDLYE	GD4275-3350-CPURYE	GD4275-3350-CPDRYE	GD4275-3350-TPLYE	GD4275-3350-TPRYE
2800mm - 7R	GD4275-2800-EPLYE	GD4275-2800-EPRYE	GD4275-2800-MPYE	GD4275-2800-CPULYE	GD4275-2800-CPDLYE	GD4275-2800-CPURYE	GD4275-2800-CPDRYE	GD4275-2800-TPLYE	GD4275-2800-TPRYE
2250mm - 5R	GD4275-2250-EPLYE	GD4275-2250-EPRYE	GD4275-2250-MPYE	GD4275-2250-CPULYE	GD4275-2250-CPDLYE	GD4275-2250-CPURYE	GD4275-2250-CPDRYE	GD4275-2250-TPLYE	GD4275-2250-TPRYE
1700mm - 3R	GD4275-1700-EPLYE	GD4275-1700-EPRYE	GD4275-1700-MPYE	GD4275-1700-CPULYE	GD4275-1700-CPDLYE	GD4275-1700-CPURYE	GD4275-1700-CPDRYE	GD4275-1700-TPLYE	GD4275-1700-TPRYE

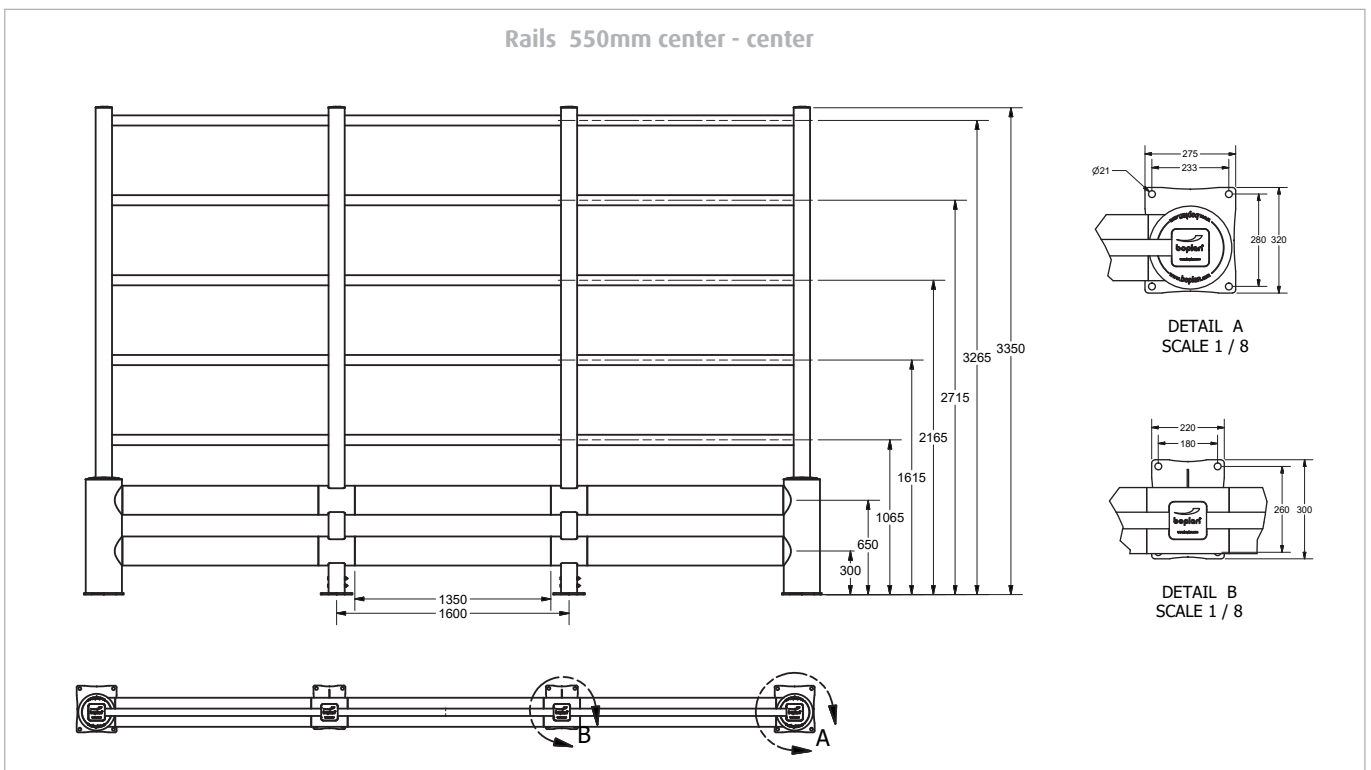

**REFERENCE LIST - TB 400 DOUBLE GRILL BARRIER**

RAIL SETS									
	CC1000mm 750mm - YE	CC1200mm 950mm - YE	CC1400mm 1150mm - YE	CC1600mm 1350mm - YE	CC1800mm 1550mm - YE	CC2000mm 1750mm - YE	Short rail CC850-1599 - YE	Long rail CC1601-2000 - YE	Conn.tube Ø250 350mm - 90° - YE
9R	GDR900-0750-1000YE	GDR900-0950-1200YE	GDR900-1150-1400YE	GDR900-1350-1600YE	GDR900-1550-1800YE	GDR900-1750-2000YE	GDR909-1599-SRYE	GDR909-2000-LRYE	GDR900-0350-C259YE
7R	GDR700-0750-1000YE	GDR700-0950-1200YE	GDR700-1150-1400YE	GDR700-1350-1600YE	GDR700-1550-1800YE	GDR700-1750-2000YE	GDR709-1599-SRYE	GDR709-2000-LRYE	GDR700-0350-C259YE
5R	GDR500-0750-1000YE	GDR500-0950-1200YE	GDR500-1150-1400YE	GDR500-1350-1600YE	GDR500-1550-1800YE	GDR500-1750-2000YE	GDR509-1599-SRYE	GDR509-2000-LRYE	GDR500-0350-C259YE
4R	GDR400-0750-1000YE	GDR400-0950-1200YE	GDR400-1150-1400YE	GDR400-1350-1600YE	GDR400-1550-1800YE	GDR400-1750-2000YE	GDR409-1599-SRYE	GDR409-2000-LRYE	GDR400-0350-C259YE
3R	GDR300-0750-1000YE	GDR300-0950-1200YE	GDR300-1150-1400YE	GDR300-1350-1600YE	GDR300-1550-1800YE	GDR300-1750-2000YE	GDR309-1599-SRYE	GDR309-2000-LRYE	GDR300-0350-C259YE
2R	GDR200-0750-1000YE	GDR200-0950-1200YE	GDR200-1150-1400YE	GDR200-1350-1600YE	GDR200-1550-1800YE	GDR200-1750-2000YE	GDR209-1599-SRYE	GDR209-2000-LRYE	GDR200-0350-C259YE

**TECHNICAL DRAWINGS - TB 400 DOUBLE GRILL BARRIER**

**TECHNICAL DRAWINGS - TB 400 DOUBLE GRILL BARRIER**

