

# TB 260

## SAFETY BARRIERS

Revision: 30 January 2026 10:12 AM  
Boplan reference: TB260...



### PRODUCT SPECIFICATIONS

APPLICATION			
Environment	The TB 260 is ideal for protecting against damage caused by forklift manoeuvres. The lower tube prevents goods or pallets sliding under the barriers and hitting pedestrians or causing damage to machines or equipment.		
Impact performance at 90°	POST: 12000 Joule (Eq. to 5ton - 7,9 km/h)		
	RAIL: 21200 Joule (Eq. to 5ton - 10,5 km/h)		
MATERIAL			
Posts and rails	Extrilene® - UV resistant - Fire class E <sup>+</sup> - Non conductive - Impervious to most chemicals <sup>**</sup>		
Caps	Sustainable elastomer		
STANDARD COLOURS			
End post	Yellow RAL 1003		
Mid post	Yellow RAL 1003		
Impact Tube	Yellow RAL 1003		
BASEPLATES			
	Steel	Zinc Coated Steel	Stainless Steel
Material	Steel 37	Steel 37	Stainless steel 304
Coating	Lacquered	Electroplated + Laquered	No lacquer / No coating
Colour	High gloss black	Mat black	Natural colour

\*Classification according to EN 13501-1:2007 +A1:2009 - Fire classification of construction products and building elements.  
\*\*Ask your local sales office for resistance to specific chemicals.

FIXATIONS				
			ZC (Zinc coated)	SS (Stainless steel)
STANDARD	Wedge anchor		M12 x 120mm	M12 x 120mm
	Anchor rod (Chemical)		M12 x 120mm + Chemical resin	M12 x 120mm + Chemical resin
ALTERNATIVES	Asphalt anchor		Bolt M10 x 40mm + Screw Ø16mm	Not available
	Spit anchor		Bolt M12 x 100mm + Plug Ø20mm	Not available

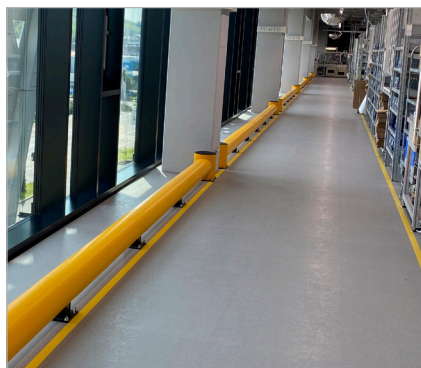
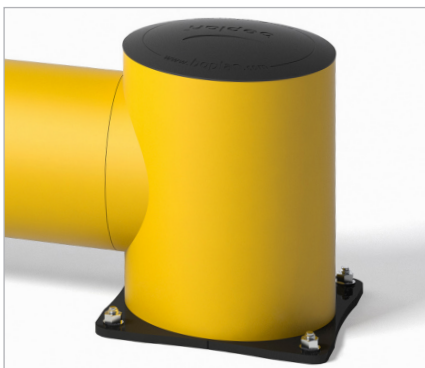

**FEATURES AND FUNCTIONALITY - TB 260**

SIZE	
Height end posts	300 mm
Height mid post	260 mm
Profile section tubes	Ø200 mm (11 mm thick)
Profile section end posts	Outer tube: Ø250 mm (11 mm thick) Inner profile: 112 mm x 112 mm (10 mm thick)
Profile section mid posts	Profile: 112 mm x 112 mm (10 mm thick)
Standard rail length	1350 mm (other sizes: 750 mm - 1750 mm)
Baseplate	End Post: 275 mm x 275 mm (10mm thick) Mid Post: 180 mm x 180 mm (10mm thick)

REQUIREMENTS	
Concrete quality	minimum C25/30
Concrete floor plate thickness	minimum 150 mm
Concrete slab dimension around posts (mm)	600 (h) x 600 (w) x 500 (d)
Operational temperature	-10°C up to +40°C
Water and humidity	<b>Steel (standard):</b> dry indoor use only. <b>Zinc coated:</b> outdoor use in most environments. <b>Stainless steel:</b> outdoor use or frequent exposure to water and humidity.

**boplan** **IMPACT LABEL FOR SAFETY BARRIERS**

**BOPLAN TB 260**

IMPACT RATING	45°	90°
E80 < 80 kJ		
E60 < 60 kJ		
E50 < 50 kJ		
E40 < 40 kJ		
E35 < 35 kJ	<b>30,0 kJ</b>	
E30 < 30 kJ		
E25 < 25 kJ		<b>21,2 kJ</b>
E20 < 20 kJ		
E15 < 15 kJ		
E10 < 10 kJ		
E5 < 5,0 kJ		
E2 < 2,5 kJ		

TEST CONDITIONS	TEST VEHICLE	ACCREDITED TEST LABORATORY
TEMPERATURE: 20°C / 68°F IMPACT HEIGHT: 160 mm / 6 1/4 Inch IMPACT ANGLE: 90° TEST FLOOR: CONCRETE SLAB C25/30 - 160 mm / 6 Inch MANUFACTURER ANCHOR PULL OUT: 7,9 kN	WEIGHT: 2300 KG / 5070.63 lbs TYPE: COMMERCIAL FORK LIFT SIZE (L x W x h): 1890x1020x1970 mm / 74x40x78 Inch CONTACT AREA: STEEL BUMPER WIDTH: 600 mm / 24 Inch	620 Route des Fromentaux 01500 Saint-Maurice-de-Rémens 01360 Beligneux France

**SUCCESS CRITERIA** VEHICLE STOPPED - ASI (ACCELERATION SEVERITY INDEX) < 0.5 **IL-TB260-20250103**

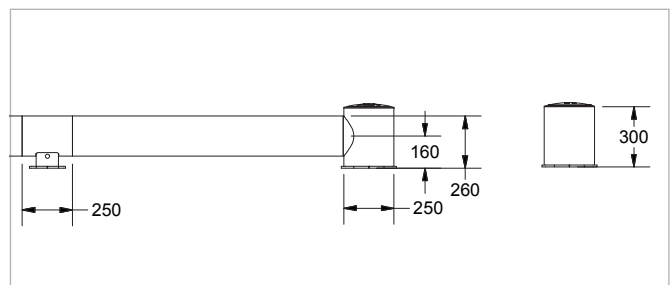
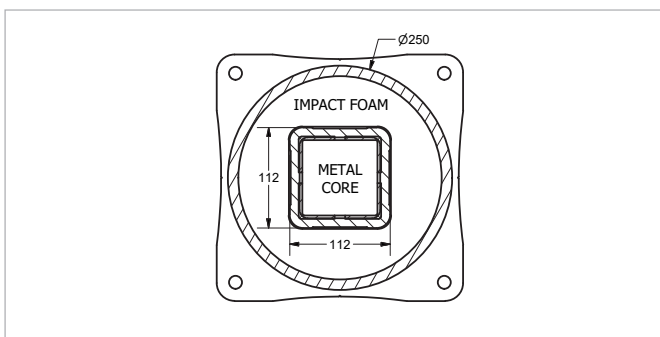
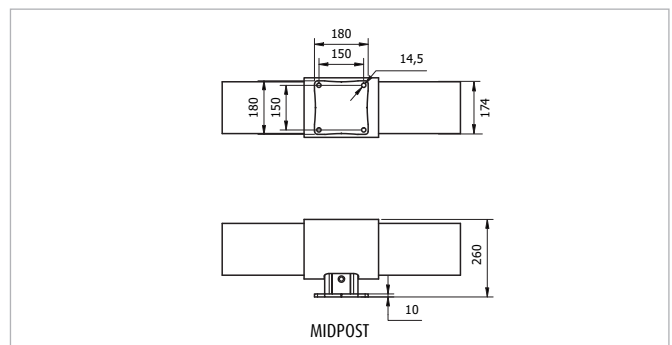
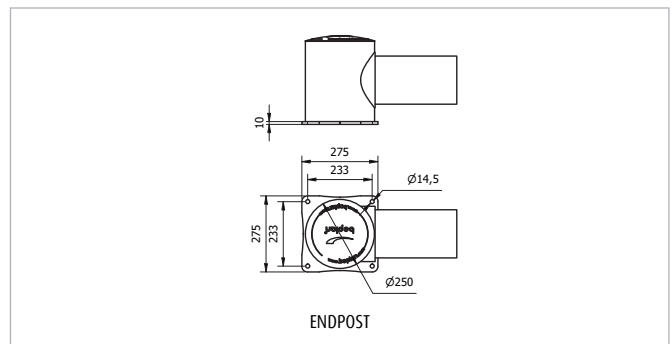

**REFERENCE LIST - TB 260**

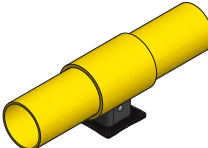
POSTS		
End post End post - ZC End post - SS	TB2600-0001-EPYE TB2600-0001-EPYEZ TB2600-0001-EPYES	
Mid post Mid post - ZC Mid post - SS	TB2600-0001-MPYE TB2600-0001-MPYEZ TB2600-0001-MPYES	

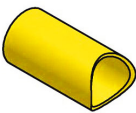
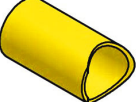
CURVES		
Conn.tube Ø250 Curve 350mm - YE	TB2600-0350-C250YE	
Conn.tube Ø250 - 90° Curve 350mm - YE	TB2600-0350-C259YE	

RAIL SETS			
	Tube length (A)	CC length (B)	Reference
Standard rail	750 mm	1000 mm	TB2600-0750-1000YE
Standard rail	950 mm	1200 mm	TB2600-0950-1200YE
Standard rail	1150 mm	1400 mm	TB2600-1150-1400YE
Standard rail	1350 mm	1600 mm	TB2600-1350-1600YE
Standard rail	1550 mm	1800 mm*	TB2600-1550-1800YE
Standard rail	1750 mm	2000 mm*	TB2600-1750-2000YE
Short rail	600-1349 mm	850-1599 mm	TB2609-1599-SRYE
Long rail	1351-1749 mm	1601-2000 mm*	TB2609-2000-LRYE

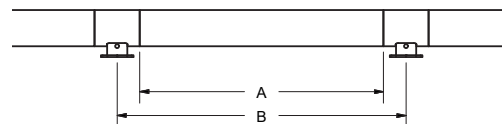

\* The impact performance has not been tested for tube lengths > 1600 mm. Only use these lengths for non - critical applications.

**REFERENCE LIST - TB 260**

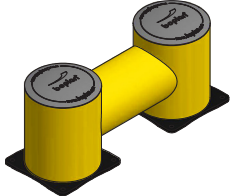
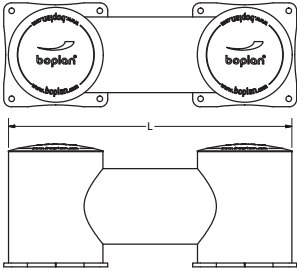
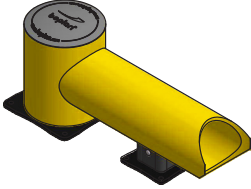
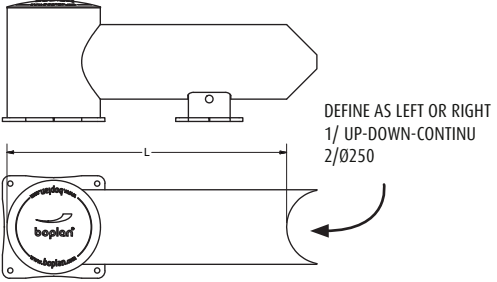
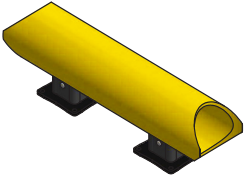
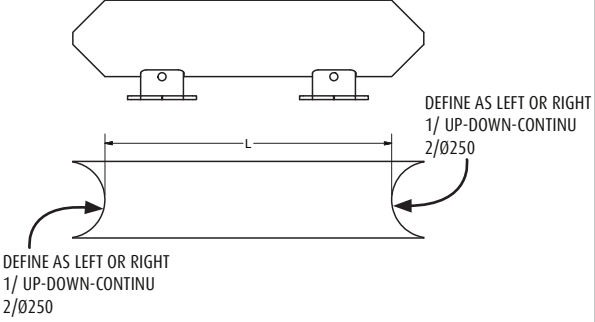
FIXED UNITS					
TYPE	LENGTH	BASE	REFERENCE YE		
no curves	750 mm	Steel ZC SS	TB2600-0750-FUYE TB2600-0750-FUYEZ TB2600-0750-FUYES		
	751-1750 mm	Steel ZC SS	TB2601-1750-FUYE TB2601-1750-FUYEZ TB2601-1750-FUYES		
1 curve	750 mm	Steel ZC SS	TB2600-0750-FU1CYE TB2600-0750-FU1CYEZ TB2600-0750-FU1CYES		
	751-1750 mm	Steel ZC SS	TB2601-1750-1CYE TB2601-1750-1CYEZ TB2601-1750-1CYES		
2 curves	750 mm	Steel ZC SS	TB2600-0750-FU2CYE TB2600-0750-FU2CYEZ TB2600-0750-FU2CYES		
	751-1750 mm	Steel ZC SS	TB2601-1750-FU2CYE TB2601-1750-FU2CYEZ TB2601-1750-FU2CYES		